

# **READ AND FOLLOW ALL SAFETY INSTRUCTIONS!**

## **SAVE THESE INSTRUCTIONS!**

### **IMPORTANT SAFEGUARDS READ AND FOLLOW ALL SAFETY INSTRUCTIONS.**

- Do not let power supply cords touch hot surfaces.
- Do not mount near gas or electric heaters.
- Use caution when servicing batteries. Battery acid can cause burns to skin and eyes. If acid is spilled on skin or in eyes, flush acid with fresh water and contact a physician immediately.
- Equipment should be mounted in locations and at heights where it will not readily be subjected to tampering by unauthorized personnel.
- The use of accessory equipment not recommended by the manufacturer may cause an unsafe condition.
- Do not use this equipment for other than intended use.

# **READ AND FOLLOW ALL SAFETY INSTRUCTIONS!**

## **SAVE THESE INSTRUCTIONS!**

M-PE24V18AH-UL  
As of 041919

# PE-24V-240W-18AH-UL

Power Enclosure, 24V DC, 240 Watts, 18 Amp-Hour Power System

## Installation/Operation Manual

- Prepare To Install
- Installation
- Install Batteries
- BDS-DIN-UPS-24-10 Manual
- Cabinet Outline and Mounting
- Wiring Guide

## Specifications

### Ratings

Input: 120V AC, single phase

Input Frequency: 60 Hz.

Maximum Input: 3.3 Amps *Use Copper Wire Only*

### Output

Volts: 24.5V DC

Amps: 1.2

### Rated Operating Time in Emergency Mode

Oper. Time: 1.2A @ 12 Hrs. Max. Load: 1.2 Amps

Install Only: MK Battery # ES17-12S Battery



CONFORMS TO  
UL STD 924

**Intertek**  
5010145

**NEWMAR**  
PoweringTheNetwork.com

# PE-24V-240W-18AH-UL

Power Enclosure, 24V DC, 240 Watts, 18 Amp-Hour Power System

## Prepare to Install

- **System Contents:** Power Enclosure, Batteries (Packed Separately)
- **Details:** Installation Manual, Located Inside of Door
- **Door Key (x 2):** Attached to One of Enclosure's Bottom Mounting Holes or Inside Enclosure
- **Wiring Accessories:** Polybag Inside Enclosure

**Caution: Heavy Equipment**

**Caution: Contains Batteries**

**Inspect Shipment Upon Receipt, Notify Carrier if Any Damage!**

### Material Provided:

- (1) NEMA 4 Power Enclosure
- (3) NPT-1/2" Liquid tight cord grips, clamping range: 6-11 mm
- (1) 12 AWG Brown battery jumper
- (2) 12 VDC, 18 AH sealed valve regulated lead acid AGM non-spillable batteries

**Overall Case Dimensions:** 30" H x 23" W x 10.5" D

**Door Hinge:** Left Side



# PE-24V-240W-18AH-UL

Power Enclosure, 24V DC, 240 Watts, 18 Amp-Hour Power System

## Installation

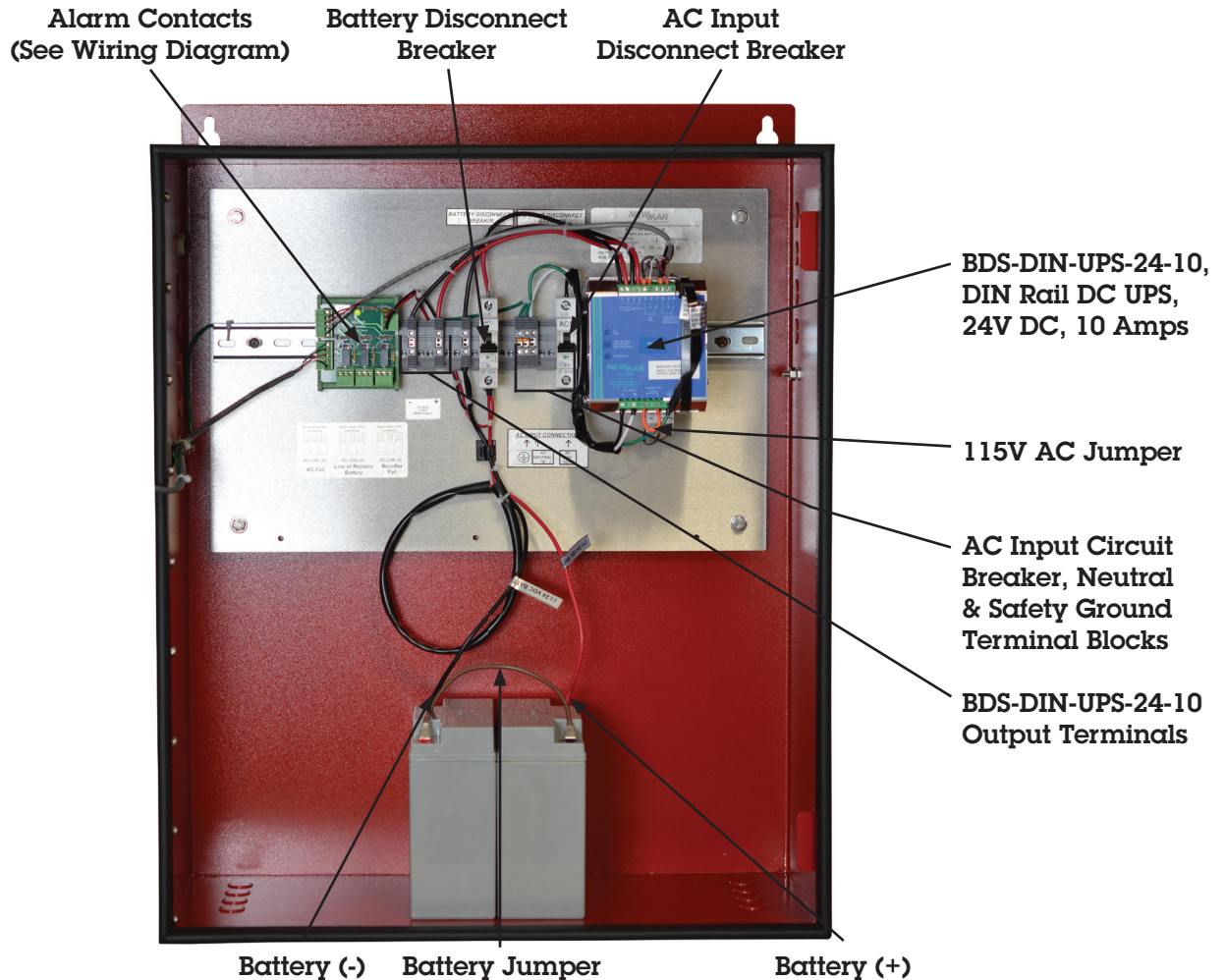

1. Mount enclosure on wall (customer supplied hardware) - see enclosure mounting drawings
2. Ensure both AC & battery disconnect circuit breakers are in OFF position
3. Qty. 3 liquid tight cord grips (NPT 1/2") are provided with the PE enclosure (clamping range: 6-11 mm). Two sets of four drill locators/dimples are provided on the upper left & right hand sides for drilling cable feed-thru holes. **NOTE:** Metal shavings can cause permanent damage to electronics. We recommend covering the electronics with a rag before drilling and remove shavings before energizing the PE System. Identify what drill size is required (7/8" drill for NPT-1/2") for your installation for the following cables and install cable fittings:
  - A. AC Input
  - B. DC Output to BDA, installer provided
  - C. Alarm contacts (AC FAIL, BATT. LOW & RECTIFIER/CHARGER FAIL), installer provided
4. Provide 120V AC (15A) circuit to PE System and connect to AC input breaker (Hot) & terminal blocks (Neutral & Earth Ground).
5. Route BDA amplifier DC input cables thru cord grip, connect to "OUTPUT LOAD (BDA INPUT)" terminals
6. Route alarm cables through cord grip, connect to green pluggable alarm terminal blocks (see wiring diagram).



# PE-24V-240W-18AH-UL

Power Enclosure, 24V DC, 240 Watts, 18 Amp-Hour Power System

## Install Batteries

7. Install batteries in to enclosure per photograph
8. Connect the single battery jumper per photograph
9. Connect battery cables from Battery disconnect circuit breaker and DC ground terminal block to 24 volt battery string terminals per photograph/wiring diagram.
10. Energize 120V AC circuit
11. Turn on PE System AC disconnect circuit breaker and verify BDS-DIN-UPS-24-10 powers up. After one minute you should see the following:
  - A. AC FAIL LED: Off
  - B. BATTERY LOW/BATTERY REPLACEMENT LED: On (extinguishes when battery disconnect breaker is turned on, batteries connected)
  - C. DIAGNOSIS LED: 2 Blink/Pause
12. Confirm the BDA amplifier is receiving power
13. Confirm battery polarity is correct: RED wire to Battery Positive (+) & BLACK wire to Battery Negative (-). Turn on the battery disconnect circuit breaker, the diagnostic LED on the BDS unit should show one of the following:
  - A. 1 Blink/Second = Float Mode
  - B. 3 Blink/Second = Bulk charging mode (battery requires charge)
14. Verify battery voltage is approximately 27.6V DC (Float mode)

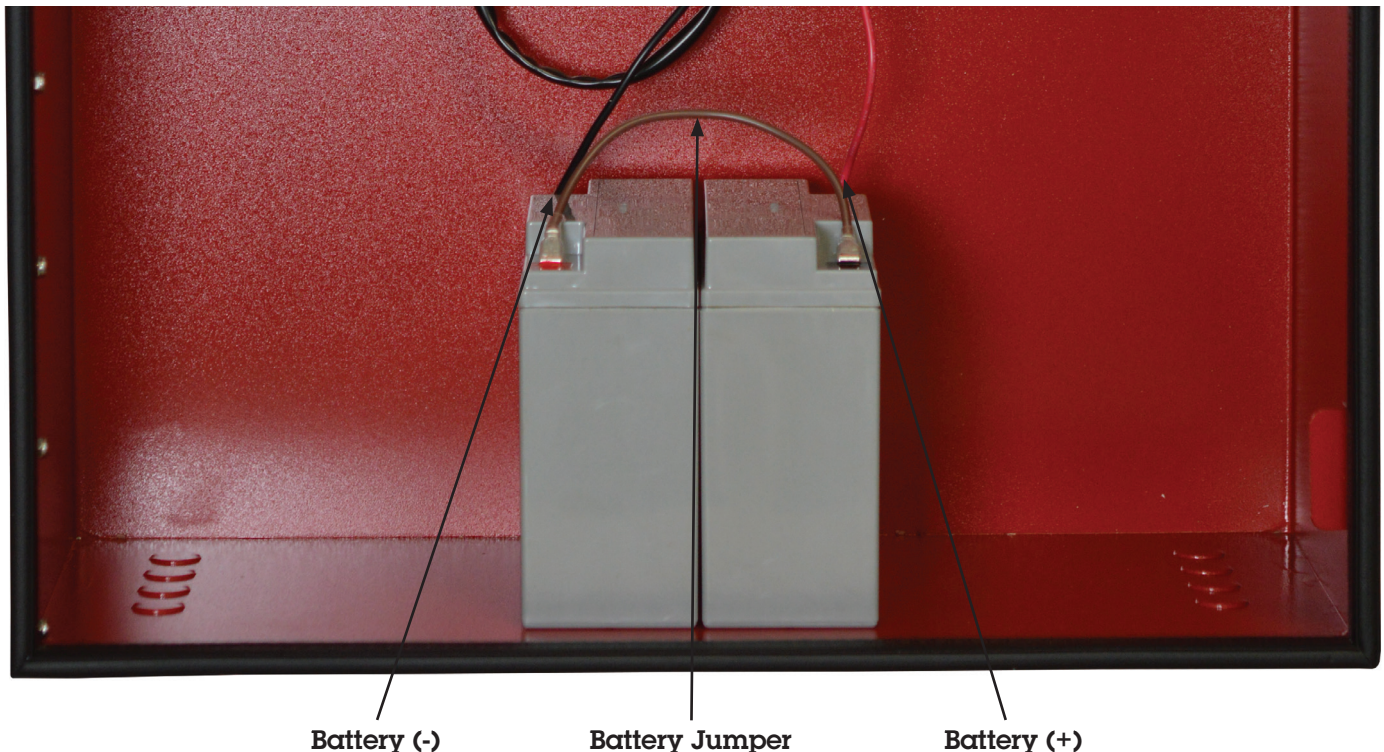



## DIN Rail UPS

# DC UPS / Battery Detection System

Model: BDS-DIN-UPS 24-10

## Installation / Operation Manual



### Table of Contents

Section	Page	Section	Page
Quick Start	2	4) Settings	7
1) General Information	4	A) Battery Type/Charge Curve	7
Materials Provided	4	5) Operation	7
Optional Equipment	4	A) Status Indicator LED's	7
2) Safety Information	4	B) LVD	8
3) Installation/Wiring	4	6) Protection	8
A) Mounting	4	7) Specifications	9
B) Wiring	5	8) Troubleshooting	10
1. AC Input	5	9) Warranty	10
2. Output	5		
C) Alarm Contacts, Form C	5		
D) Temperature Compensation Sensor	6		

M-BDSDINUPS2410-ULPE  
As of 010218

# Quick Start Guide

Figure 1: Quick Start

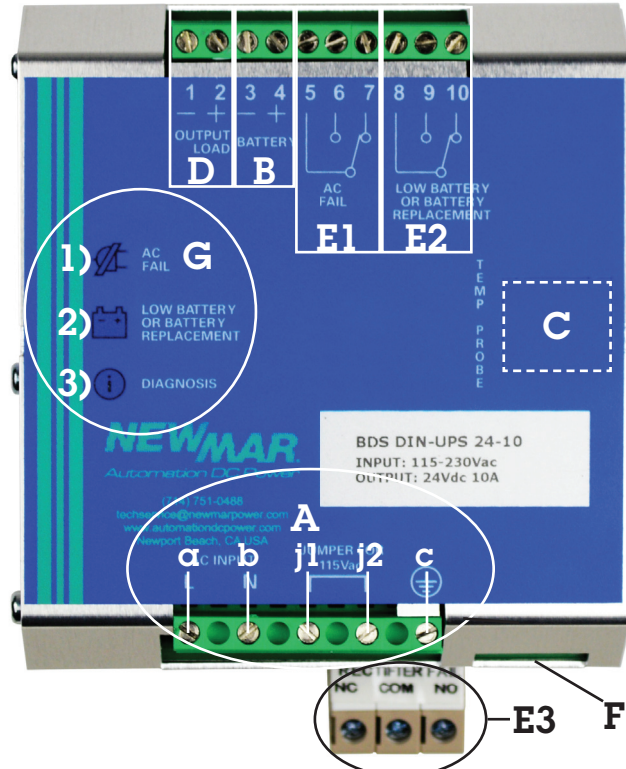

**A) AC Input:** Wire Input Block (lettered left to right)

- a) AC Hot 230 VAC: no jumper installed across j1 & j2  
AC Hot 115 VAC: wire jumper across j1 and j2
  - b) Neutral
  - c) Earth Ground
  - j1 & j2) Jumper these two inputs for 115 VAC operation
- See page 5 for details.

**B) Battery Output:** one terminal each for plus and minus.  
See page 5 for details.

**C) Battery Temperature Sensor (optional):** Plug in port (RJ-45). See page 6 for details.

**D) Output to Load:** The unit has a load priority circuit, all produced power is made available to the load, remaining power is available for battery charging. See page 5 for details.

**E) Form C Contacts:** Activate upon:

- E1.** AC Power Fail
- E2.** Low Battery: (22.8V)
- E3.** Charger Power Circuit Fail

**F) System Settings:** via plug-in jumper programming terminals located on bottom of the unit.

- a. Install jumper per illustration below (Table 1) to:
    - i. Select float voltage per Battery Type and enable Absorption Charge (see page 7 for details)
- See page 7 for details on functional settings.

**Mounting DIN DC UPS to DIN Rail**

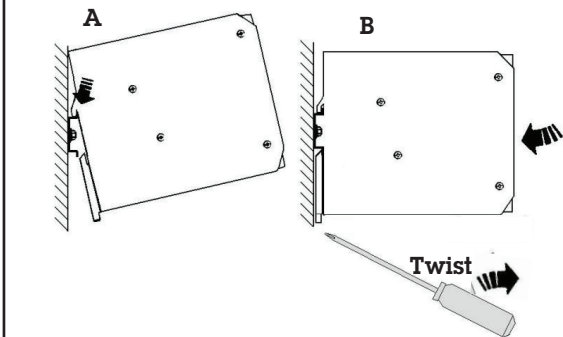

**Removing DIN DC UPS from DIN Rail**

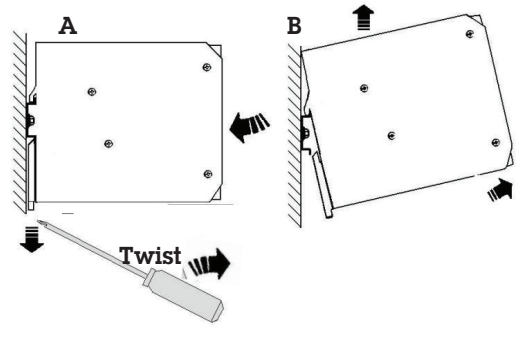

Insert flat head screwdriver in slot of bottom tab and twist to extend bracket

**G) Status Indicator LED's**

1. Power Source: Operating on battery back-up power (LED On). LED extinguishes when AC is present.
2. Low battery @ 70% discharge point, i.e. 30% capacity remains
3. Charger Output Status and Fault Mode Diagnosis: by blink code:

**Charge Status Blink Code:**

- Bulk: 5 blink/second - Recovery
- Absorption: 2 blink/second - Bulk
- Float: 1 blink/second

**Fault Mode Diagnosis Blink Code:**

- Reverse Polarity: 1 blink, pause
- Battery Not Connected: 2 blink, pause
- Overload or Short Circuit: 4 blink, pause
- Low battery: steady on, 5 blink, pause
- Bad Thermal Sensor: 7 blink, pause and diagnostic

See page 7 for details.

**Table 1: System Settings: Battery Selection/Absorption Charge and Functional Settings**

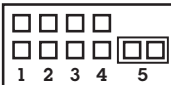
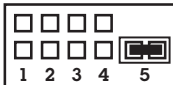
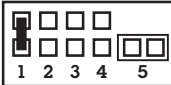
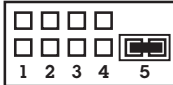
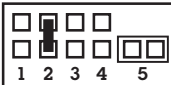
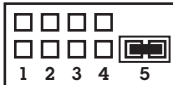
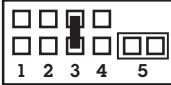
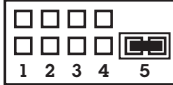
Battery Type Selection	Float Charge/ Jumper Insert Position	Absorption Charge Enable/ Jumper Insert Position
Open Lead (Default)	 <p>None</p> <p>26.76 VDC</p>	 <p>Pos. 5</p> <p>28.8 VDC</p>
Sealed Lead Low Insert Jumper: Pos. 1	 <p>Pos. 1</p> <p>27.0 VDC</p>	 <p>Pos. 5</p> <p>28.8 VDC</p>
Sealed Lead High Insert Jumper: Pos. 2	 <p>Pos. 2</p> <p>27.24 VDC</p>	 <p>Pos. 5</p> <p>28.8 VDC</p>
Gel Battery Insert Jumper: Pos. 3	 <p>Pos. 3</p> <p>27.6 VDC</p>	 <p>Pos. 5</p> <p>28.8 VDC</p>

\* Note: voltages above are at 20° C with no battery temp. sensor connected.



## 1) General Information

This DIN rail mount DC UPS Combines all system power functions: power supply, battery charger, UPS circuitry and status monitoring in one compact unit that produces 24 volt, 10 amps allocated via outputs for load and battery:

- Load output: "load priority" distribution ensures power is dedicated first to the load, with remainder then allocated to battery charging, thus preventing a discharged battery from impacting operation of critical loads.
- Battery output: 3 step charging for rapid battery recovery, programmable for battery type, with optional temperature compensation sensor
- Battery automatically on line to support load anytime AC fails
- Low voltage disconnect protects battery from total discharge
- Low battery alarm
- High operating temperature range to 70° C
- Alarm contacts: AC fail, battery status/condition

This DC UPS is fitted with special monitoring and alarm features designed to comply with the latest codes related to public safety in-building wireless communications back-up power requirements, as set forth by NFPA, section 1221.

In normal operation, the unit supplies power to the transmitter/antennas and maintains the back-up battery. Should an event occur that could cause interruption in power, self-diagnosis signals are sent via form C contacts notifying the network operators the system is running in a critical power condition and that potential communications failure is imminent.

- 1) AC Fail
- 2) Low battery voltage indicating battery discharged by 70% (i.e. 30% capacity remaining)
- 3) Internal charger/power circuit fail

### Materials Provided:

- 1 ea. DIN-UPS unit with integral DIN rail mount clip
- 3 ea. Jumper tabs for programming
- 1 ea. Jumper wire (orange) for 115 volt input operation

### Optional Equipment:

Temperature Compensation Sensor, P/N: 468-4510-0



## 2) Safety Information

**WARNING** – Explosion Hazard. Do not disconnect loads or battery unless AC input and battery have been switched off.

**WARNING** – Explosion Hazard. This product is not certified for Class 1, Div 2 applications.

**WARNING** – Switch off or remove AC input and battery power before wiring the BDS-DIN-UPS 24-10. Never work on the DIN UPS when it is connected to AC input and battery. The DIN UPS must be installed in accordance with UL508 or local electrical codes depending upon the application. The DIN UPS should have a suitability sized AC input circuit breaker feeding its AC input. See specification section for maximum AC input draw for your input voltage for circuit breaker sizing.

**CAUTION:** Hot surface. Avoid touching the DIN UPS case while operating at or near its full load capacity. Remove AC and battery power and allow DIN UPS at least 10 minutes to cool before removing from DIN Rail.

## 3) Installation/Wiring

### A) Mounting:

The unit is designed for 35 mm DIN rail mounting in an enclosure and relies on convection (free air) cooling, thus must have a minimum vertical and horizontal distance to adjacent surface of 4" (10 cm) to this power supply in order to assure sufficient air flow. We recommend approximately 1/2" (10 mm) spacing between adjacent DIN Rail mounted devices. Note, that depending on the ambient temperature and load of the device, the temperature of the case can become hot to the touch.

The unit is designed for vertical mount (+/- 5°) and has an integral clip on the back to secure it to the rail. To mount, place the top tabs over the top of the DIN rail, and using a long slotted screw driver insert it in the groove at the bottom of the bracket and twist which will extend the spring loaded mounting bracket downward allowing the unit to be positioned against the DIN rail, release the bracket with DIN UPS positioned vertically and the rail will be captured and the unit secured.

Figure 2: Mounting

Figure 3: Removing

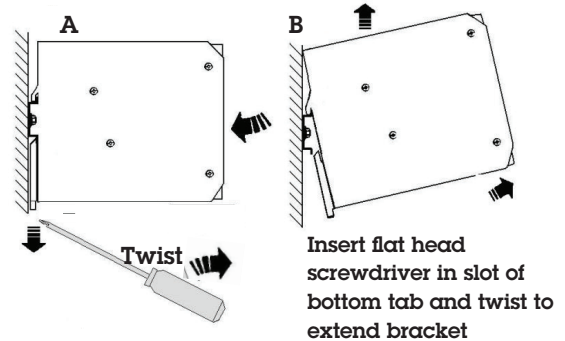
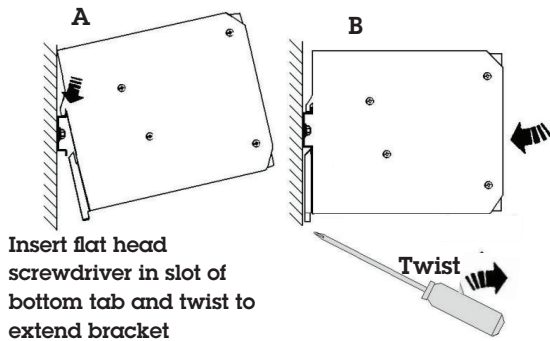

**B) Wiring**

**1. AC Input: Terminal Block (lettered left to right) - Figure 4**

- a) AC Hot (note: install jumper provided across terminals j1 and j2 for 115 VAC input)
- b) Neutral
- c) Earth Ground
- j1 & j2) Jumper these two terminals for 115 VAC operation and apply 115V hot to term a and neutral to b

Recommended wire size: 16 AWG

**2. Output**

The unit has two outputs: one connects to the Load and the other to the back-up battery. Note: the unit has a load priority circuit, all produced power first is made available to the load with remaining power made available for battery charging. The DIN UPS is isolated from the case, thus you may apply to a positive or negative ground system.

Figure 4: AC Input Terminal Block

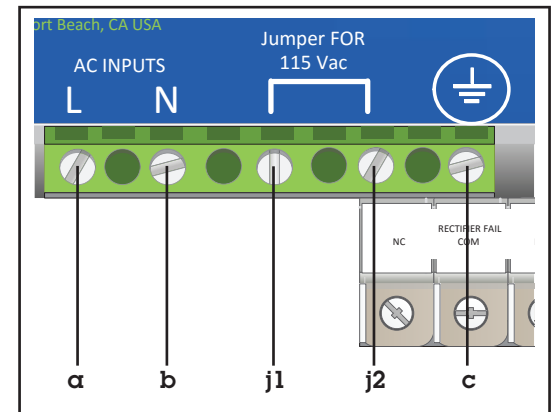
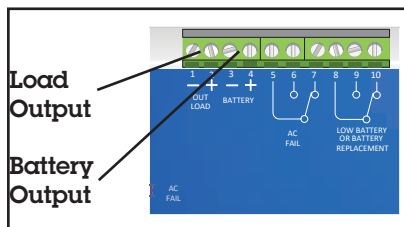

Figure 5: Output Terminals



**Battery Output:** See page 3, Section F for programming per battery type.

**Output to Load:** terminals for plus and minus.

Fuse note: We recommend a 15 amp fuse be installed on the hot leg at battery.

**Battery/Output wires size (recommended):** 16 AWG

**Terminal Block maximum wire size (recommended):** 10 AWG

**C) Alarm Contacts, Form C (Isolated):**

Form C Contacts for remote monitor: Activate upon:

- E1.** AC Power Fail
- E2.** Low Battery, 22.8 V DC - @ 70% Discharge Point\*, i.e. 30 capacity remains
- E3.** Charger Power Circuit Fail

\* Applicable to battery system with 2 - 5 amp continuous load with 100 - 150 AH capacity

**Table 2: Alarm Contacts**

Input	Contact				1 AC Fail LED	2 Low Battery LED	3 Diagnosis LED
	5-6	5-7	8-9	8-10			
AC only	closed	open	open	closed	off	on	2 Blink-Pruse
AC + Batt	closed	open	closed	open	off	off	1 Blink/sec
Batt only	open	closed	closed	open	on	off	off
Low Batt	open	closed	open	closed	on	on	off

\* Labeled Low Battery or Battery Replacement on Front Panel

**Figure 6: Alarm Contacts Terminals, Form C (Isolated)**

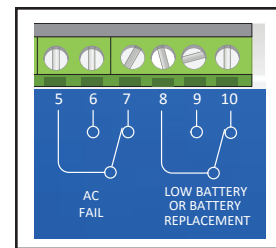

**Relay Contact Rating:**

Max. DC: 30 VDC, 1 amp; AC: 60 VAC, 1 amp: Resistive load (EN 60947-4-1)  
Min. 1mA at 5 VDC

**D) Optional Battery Temperature Compensation Sensor P/N: 468-4510-0**

To install, remove the access tab in the front panel decal labeled AUX 1, install the Temp. Sensor into the RJ-45 connector. Attach sensor to side of battery using RTV silicone.

The sensor will vary the battery charging voltage depending on the battery's temperature and charge program setting.

**Table 3: Absorption Charge Voltage & Float Charge Voltage Settings**

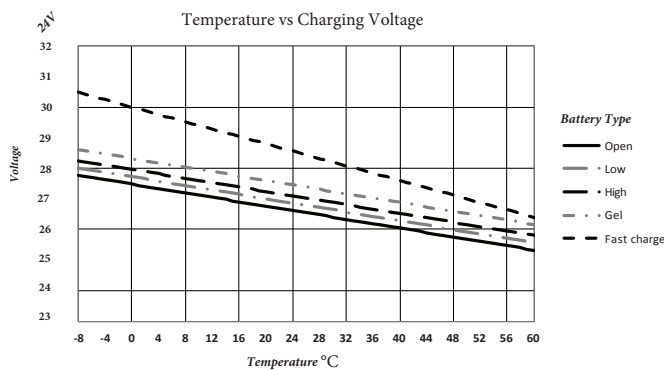

Float Voltage = Voltage @ 20° C - ( Sensor Temp ° - 20° ) x .003 x number of cells)

Fast Charge = Voltage @ 20° C - ( Sensor Temp ° - 20° ) x .005 x number of cells)

Eg. Sensor Temp = 60°

Voltage @ 20° = 26.76

Battery Cells = 12

Float: 25.32V = 26.76V - (40 x .003 x 12)

If the battery temperature is less than -20° C or greater than +60° C, an 'outside its range (temp. sensor)' alarm is signalled with code 7 blink.

If the sensor is not connected or if the sensor is defective, the LED Low Batt will illuminate and the LED Diagnosis' LED continues to show the status of the battery, i.e., trickle charge, fast charge or recovery charge.

**Figure 7: Charger/Power Circuit Fail Alarm Contacts**

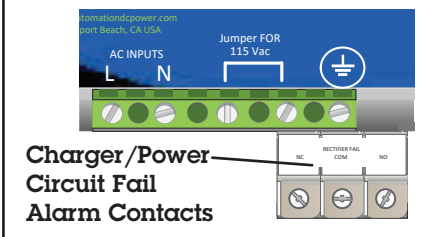

**Figure 8: Status Indicator LEDs**

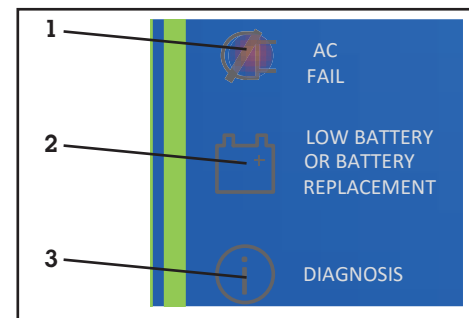

**Figure 9: Battery Temperature Sensor Access Tab**

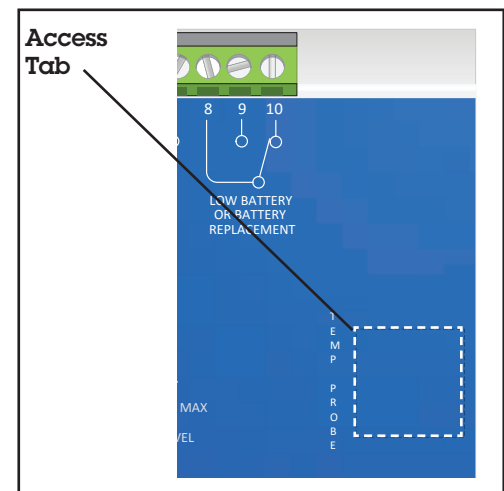

## 4) Settings

### A) Battery Type/Charge Curve

Charge curve per battery type: via programming jumpers inserted on bottom panel of unit right side.

Using programming jumper tabs provided and a small needle nose pliers, insert programming jumpers to select float voltage and enable absorption voltage per battery type. Caution, do not not program unit while connected to power.

Figure 10: Battery Type

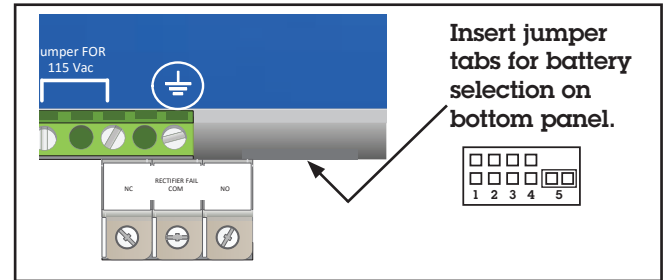

Table 4: Battery Selection/Absorption Charge

Battery Type Selection	Float Charge/ Jumper Insert Position	Absorption Charge Enable/ Jumper Insert Position
Open Lead (Default)	 None <b>26.76 VDC</b>	 Pos. 5 <b>28.8 VDC</b>
Sealed Lead Low Insert Jumper: Pos. 1	 Pos. 1 <b>27.0 VDC</b>	 Pos. 5 <b>28.8 VDC</b>
Sealed Lead High Insert Jumper: Pos. 2	 Pos. 2 <b>27.24 VDC</b>	 Pos. 5 <b>28.8 VDC</b>
Gel Battery Insert Jumper: Pos. 3	 Pos. 3 <b>27.6 VDC</b>	 Pos. 5 <b>28.8 VDC</b>

\* Note: voltages above are at 20° C with no battery temp. sensor connected.

## 5) Operation

### A) Status Indicator LED's

1. Power source: Mains or back up
  - i. AC OK (LED Off)
  - or  
AC Fail
  - ii. Operating on battery backup power (LED On) red
2. Low battery

LED illuminates when:

- Low Battery @ 70% depleted (22.8V), i.e. 30% capacity remains







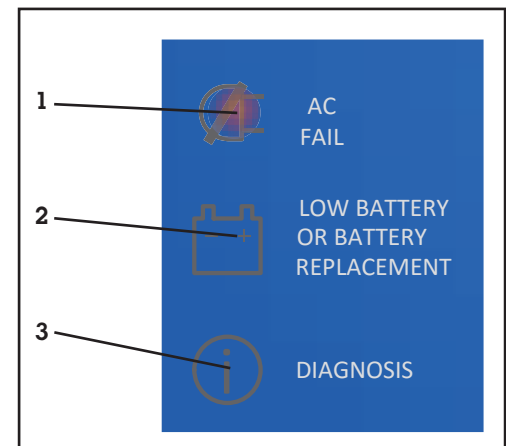

3. Diagnosis LED.

Charger output status system diagnosis and Fault mode diagnosis: by blink code (Table 6 on next page).

Figure 12: Status Indicator LEDs



**Table 6: Status Indicator LEDs**

Monitoring Control	State	LED Diagnosis (No.8)	LED Battery Fault No.7)
Charging Type	Float	1 Blink/sec	OFF
	Absorption	2 Blink/sec	OFF
	Bulk	5 Blink/sec	OFF
System Auto Diagnosis	Reverse polarity or high battery Voltage	1 Blink/pause* 	ON
	Battery Not connected, no output power	2 Blink/pause 	ON
	Over Load or short circuit on the load	4 Blink/pause 	ON
	Low battery; 45.6 volts	5 Blink/pause 	ON
	Battery Life test not possible	6 Blink/pause 	ON
	Temp. Sensor outside its range	7 Blink/pause 	ON
	Boost condition; battery discharge after 4 min. of overload.	8 Blink/pause 	ON
	Internal fault	9 Blink/pause 	ON
Low battery detected when system activated by battery start button with no AC input	10 Blink/pause 	ON	

\* Pause: 1 Second

**B) LVD)**

The unit contains a low voltage load disconnect that activates at 18 volts (1.5 vpc) which is factory set and cannot be user modified.

**6) Protection**

On the AC Input: the device is equipped with an internal fuse. If the internal fuse is blown, it is most probable that there is a fault in the unit. If this occurs, the unit must be returned to the factory.

On the DC Output Battery and Load: The device is electronically protected.

Reverse polarity: the module is automatically protected against reverse of battery polarity and connection of reverse polarity.

Over current and output short circuit: the unit limits the output current. Low voltage disconnect protects battery from deep discharge.

**Thermal protection**

Operating temperature range -12 to 70° C. Unit will produce full rated power on continuous basis to 50° C, however; system load must be reduced by 2.5% per 1° for continuous operation above 50° C. If the temperature reaches 70° C, the unit will reduce its maximum output to approximately 50% of its rating. If the temperature exceeds 70° C, the unit will shut off and restart once temperature drops.

## 7) Specifications

### Input:

**Voltage:** 90-135/ 180-305 47-63 hz

**Amperage:** 3.3 @ 120 VAC / 2.2 @ 230 VAC

**Output:** 24 volts, 10 amps total available to power loads and charge battery, with load priority distribution.

**Peak:** 30 amps 4 seconds (with battery power boost)

**Low Voltage Disconnect Point:** Approximately 18 VDC

Output ground isolated from case, may be used in positive ground applications. LVD function is lost

### Front Panel LED Indicators:

- Power Source: operating on back up – red LED
- Battery and System Diagnostics (via blink code)

### Settings/Selectors:

- Battery Type: AGM, Sealed Lead Acid, Gel-Cell

### Alarm Contacts (form C): Active:

- AC Fail (on battery back-up)
- Low Battery, 22.8V DC: indicating 70% battery discharge point (i.e. 30% capacity remains based on 2 - 5 amp continuous load on 100 - 150 AH battery)
- Charger/Power Circuit Failure

**Operating Temperature:** -12 to 70° C. Continuous to 50°, de-rate 2.5% per° C >50° C

**Cooling:** Free air convection

**Efficiency:** 91%

**Humidity:** to 95%, to 25° C

**Power Dissipation:** 28 Watts

**BUT's:** 96

### Protection:

- Low Voltage disconnect at 1.5 volts per cell (18 VDC)
- Internal fuse
- Current limiting
- Short circuit
- Reverse polarity
- Thermal overload shut down and recovery
- IP 20
- Designed to UL 1950

**Terminal Blocks:** Screw type

**Mounting:** DIN Rail Bracket 35 mm

### Auxiliary Jacks

**AUX 1:** Battery Temperature Compensation via optional Battery Temp. Sensor, P/N 468-4510-0, with RJ-45 connector

## 8) Troubleshooting

Symptom	Possible Cause	Corrective Action	Section
A. Battery requires excessive re-charge time	<ol style="list-style-type: none"> <li>1. Load at or near max. recommended load providing minimal current available for charging</li> <li>2. Charging level current set to low</li> </ol>	<ol style="list-style-type: none"> <li>1. Reduce load or split load between two separate DIN UPS units</li> <li>2. Adjust "Battery Charging Level" control knob to higher level</li> </ol>	
B. Load turns off after a couple of seconds when running on battery	<ol style="list-style-type: none"> <li>1. Time buffer set to incorrect position</li> <li>2. Batteries not charged, due to high load demand</li> </ol>	<ol style="list-style-type: none"> <li>1. Verify correct setting with manual</li> <li>2. Reduce load or split load between two separate DIN UPS units</li> </ol>	
C. No absorption voltage	<ol style="list-style-type: none"> <li>1. Absorption jumper not installed</li> </ol>	<ol style="list-style-type: none"> <li>1. Install provided jumper in position 5</li> </ol>	
D. Unit does not turn on	<ol style="list-style-type: none"> <li>1. AC input is 115 VAC, no jumper wire installed</li> </ol>	<ol style="list-style-type: none"> <li>1. Install 115V jumper wire across j1 and j2</li> </ol>	
E. Trips AC input breaker	<ol style="list-style-type: none"> <li>1. AC shorted to case</li> <li>2. Defective unit</li> </ol>	<ol style="list-style-type: none"> <li>1. Verify correct AC input wiring</li> <li>2. Contact technical service</li> </ol>	
F. No output	<ol style="list-style-type: none"> <li>1. DC output wired backwards or shorted</li> <li>2. No AC input</li> <li>3. Excessive temperature or blocked ventilation</li> <li>4. Defective unit</li> </ol>	<ol style="list-style-type: none"> <li>1. Remove AC input and check DC wiring</li> <li>2. Verify correct AC input and jumper wire installed if powering from 115 VAC</li> <li>3. Improve ventilation, unblock vent holes</li> <li>4. Contact technical service</li> </ol>	
G. No voltage on battery output terminals	<ol style="list-style-type: none"> <li>1. No battery installed (voltage required for battery output to turn on)</li> <li>2. Missing or blown battery wiring fuse</li> </ol>	<ol style="list-style-type: none"> <li>1. Install batteries</li> <li>2. Replace missing or blown battery wiring fuse</li> </ol>	
H. Diagnosis LEDs always blinking	<ol style="list-style-type: none"> <li>1. Normal operation</li> </ol>	<ol style="list-style-type: none"> <li>1. Refer to Chart 2: Diagnosis Table</li> </ol>	

## 9) Warranty

Newmar warrants that the BDS-DIN-UPS 24-10 DIN Rail UPS to be free from defects in material and workmanship for two years from date of purchase. If a problem with your BDS-DIN-UPS 24-10, or if you have any questions about the installation and proper operation of the unit, please contact NEWMAR's Technical Services Department:

Phone: 714-751-0488 - From the hours of 7:30 a.m. to 5:00 p.m. weekdays, P.S.T.;

Fax: 714-372-7930

E-mail: [techservice@newmarpower.com](mailto:techservice@newmarpower.com)

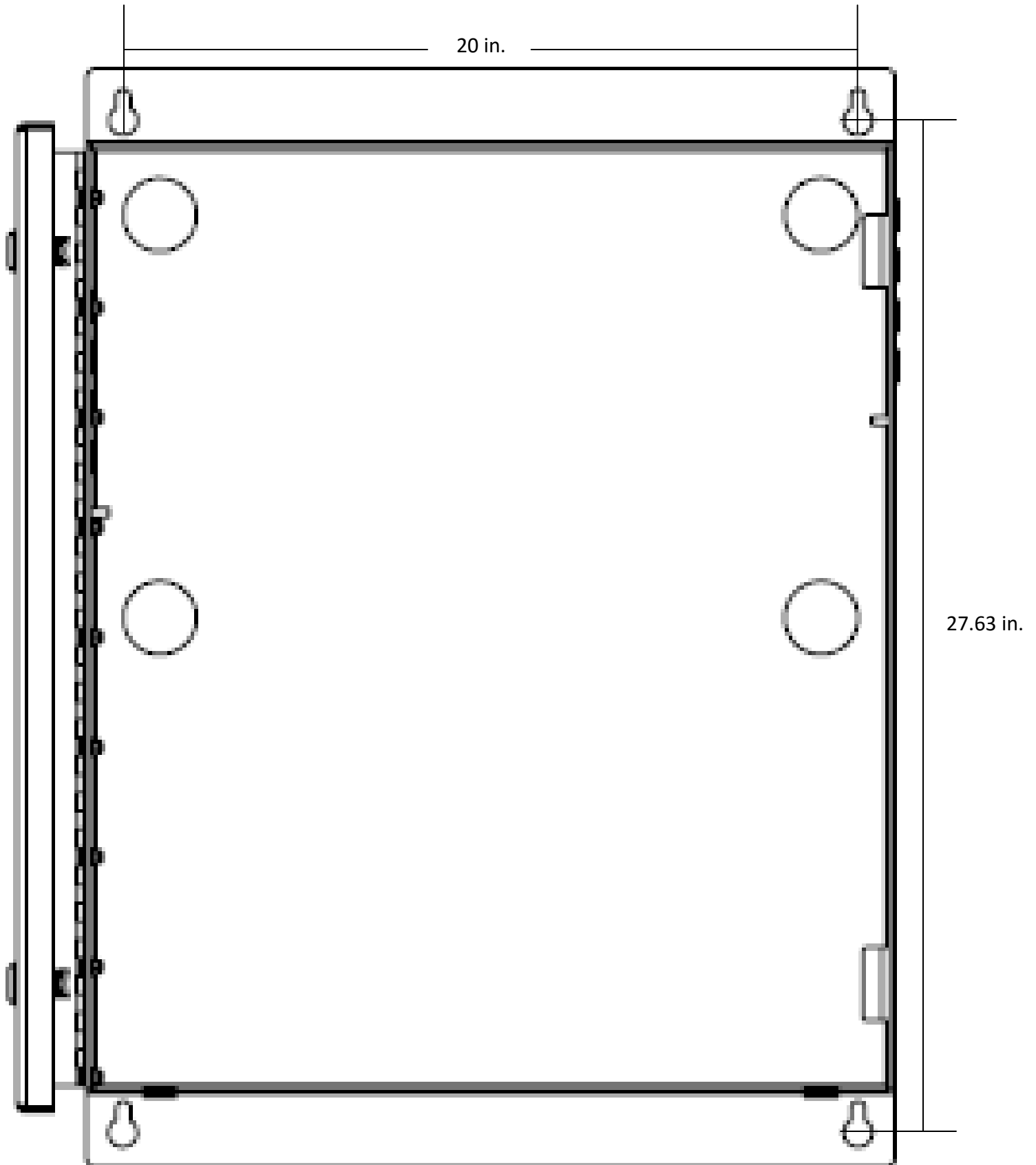



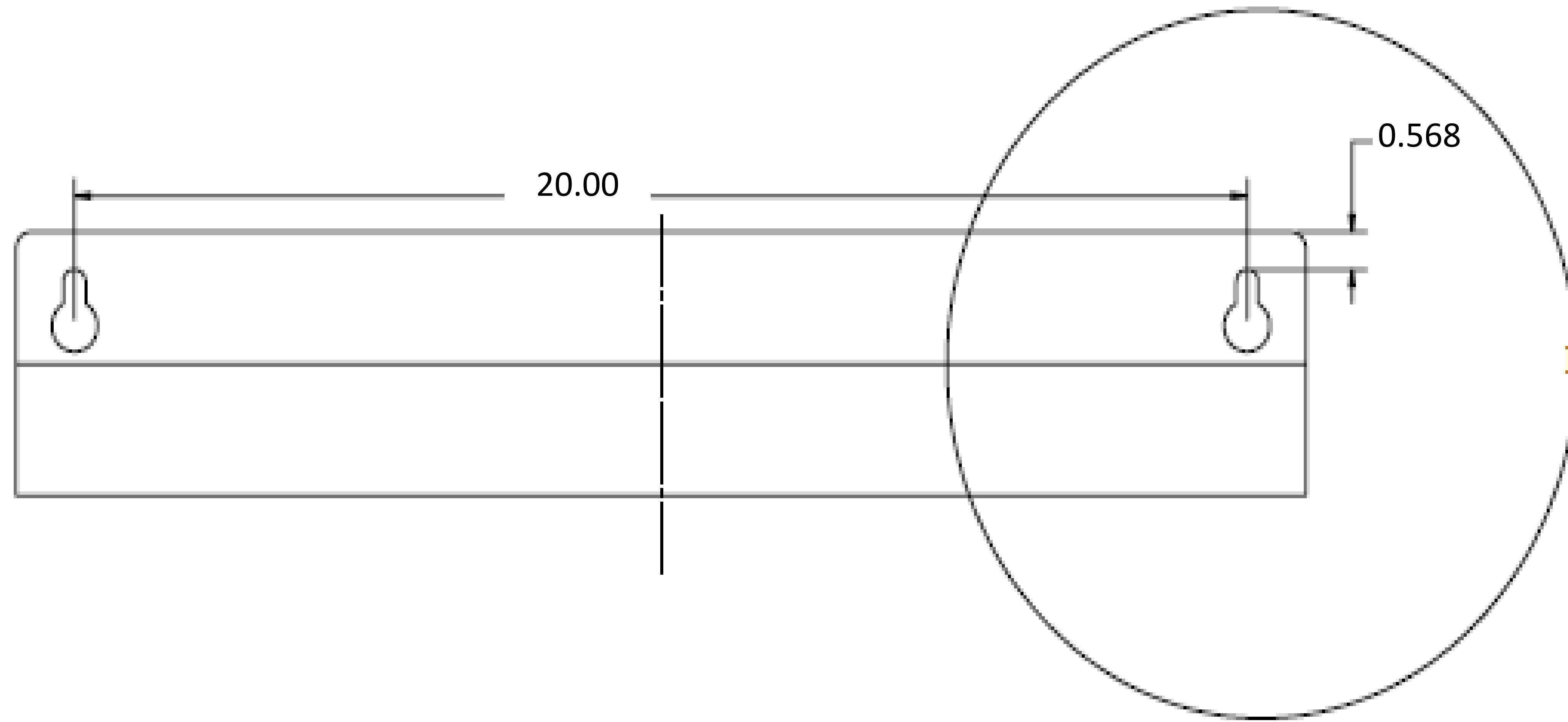
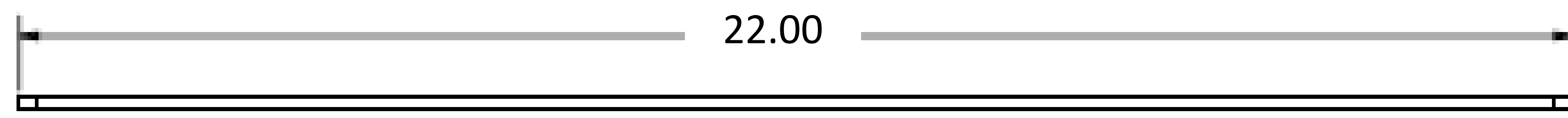

**TOP MOUNTING LIP**

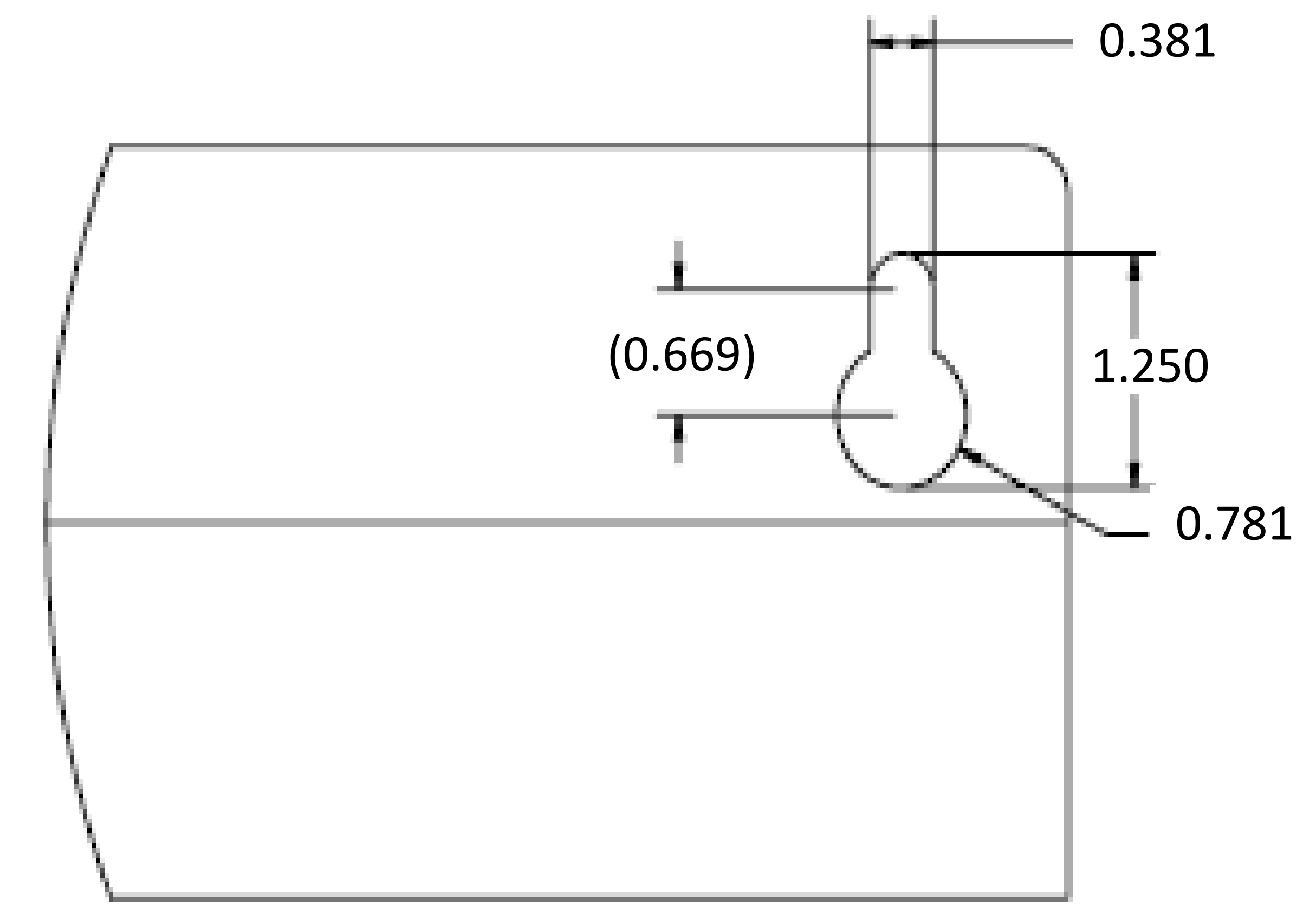

**DETAIL B  
SCALE 1:1**

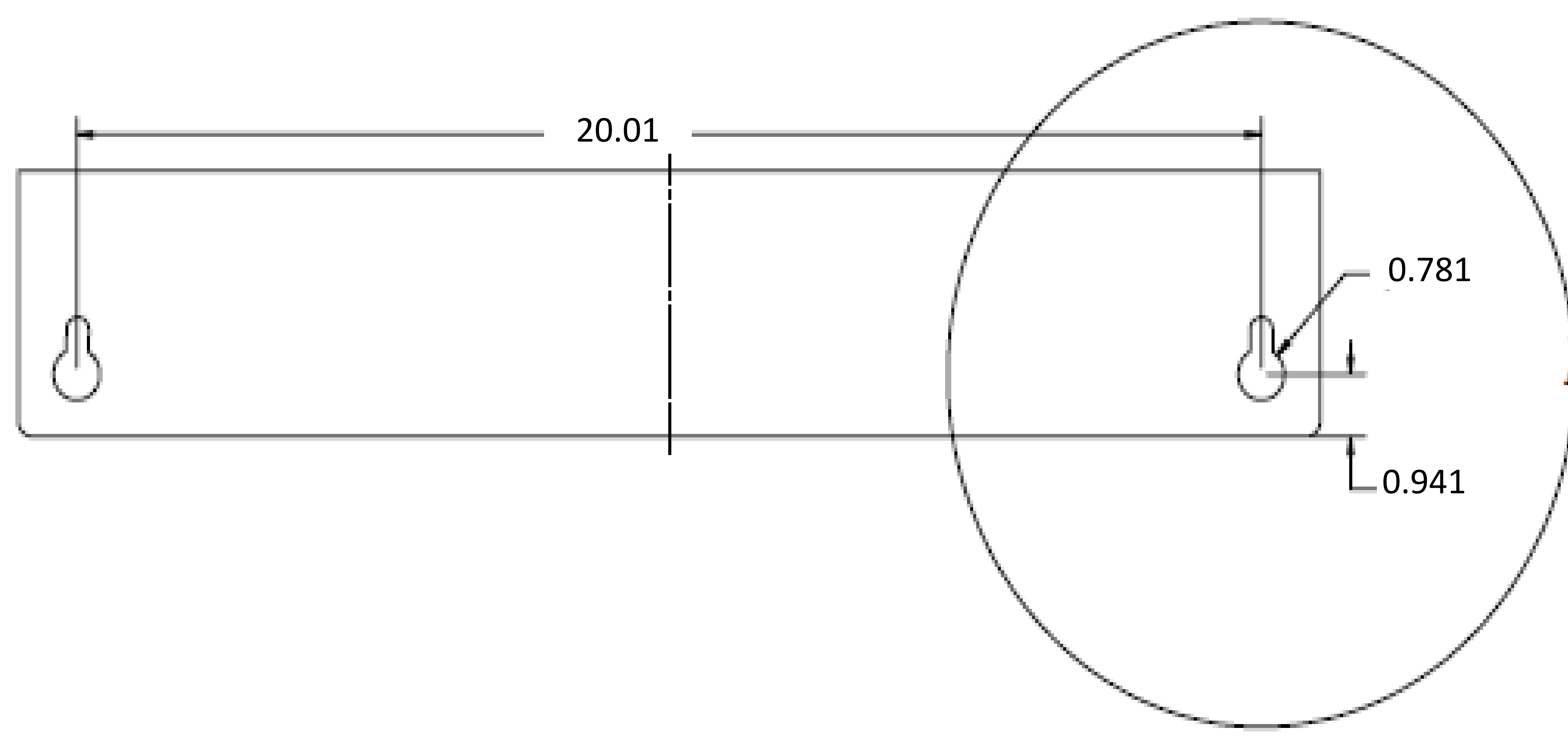
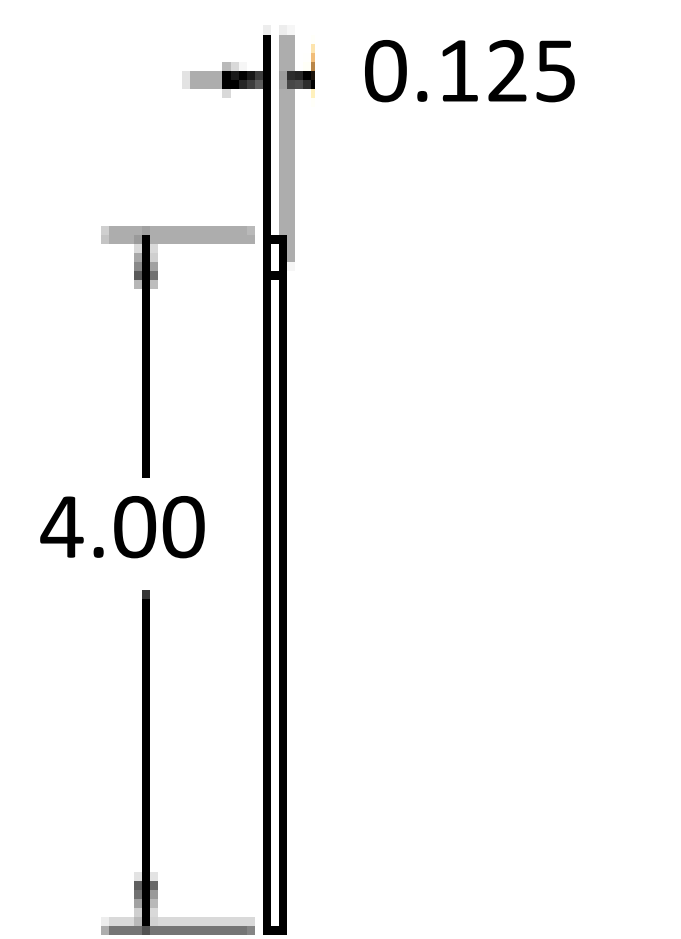

**BOTTOM MOUNTING LIP**

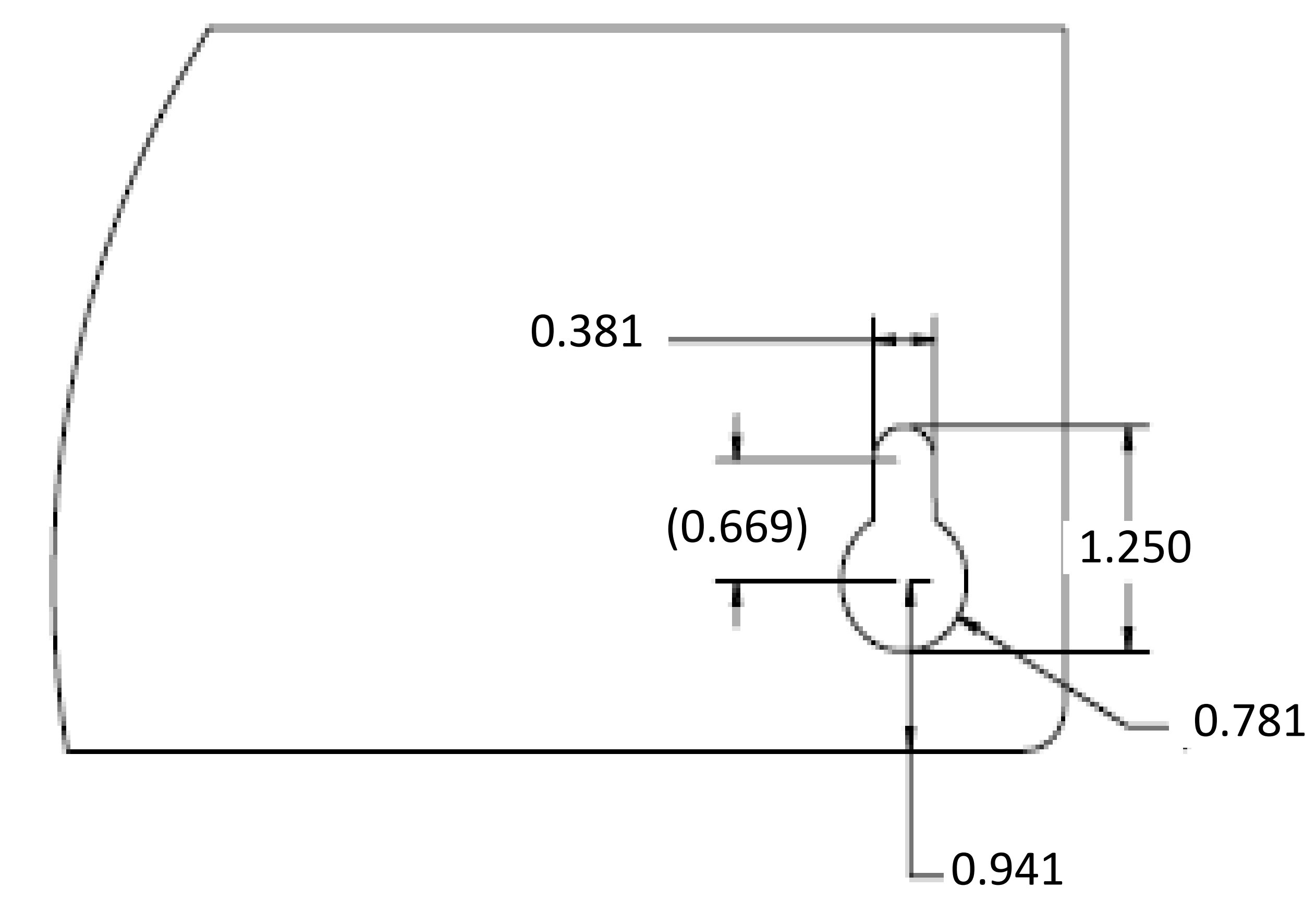

**DETAIL A  
SCALE 1:1**

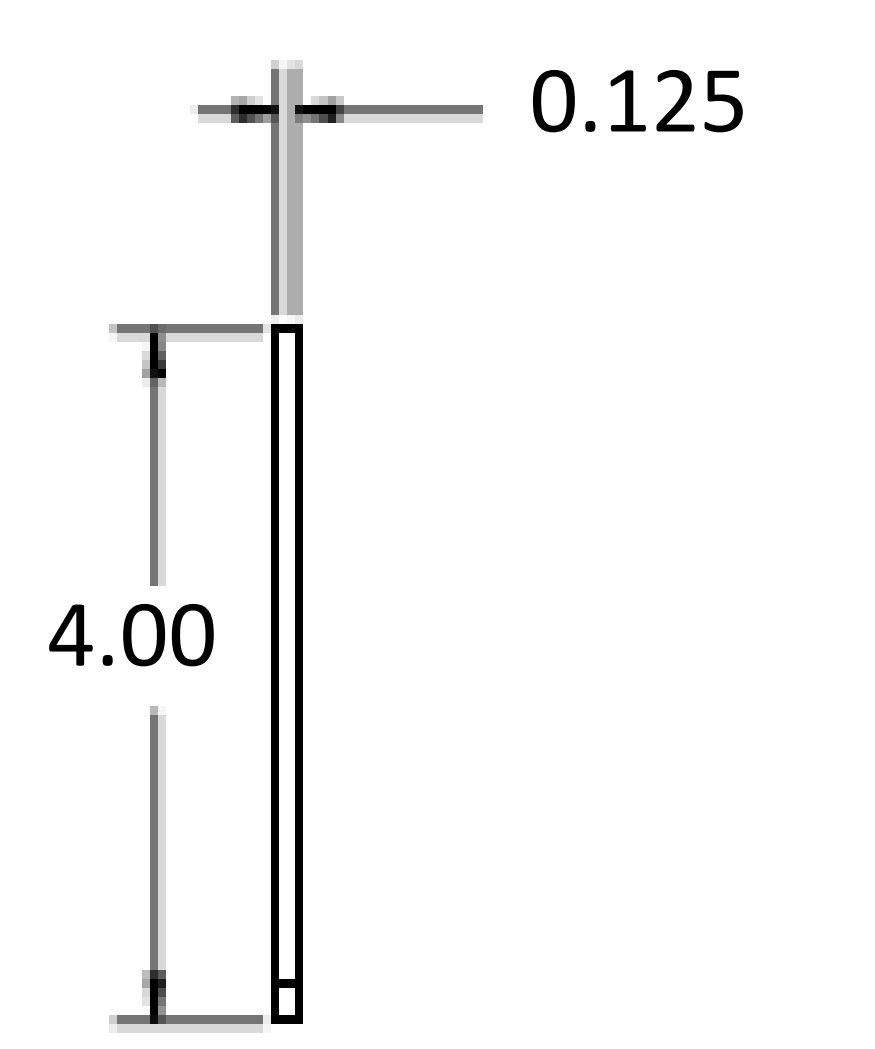

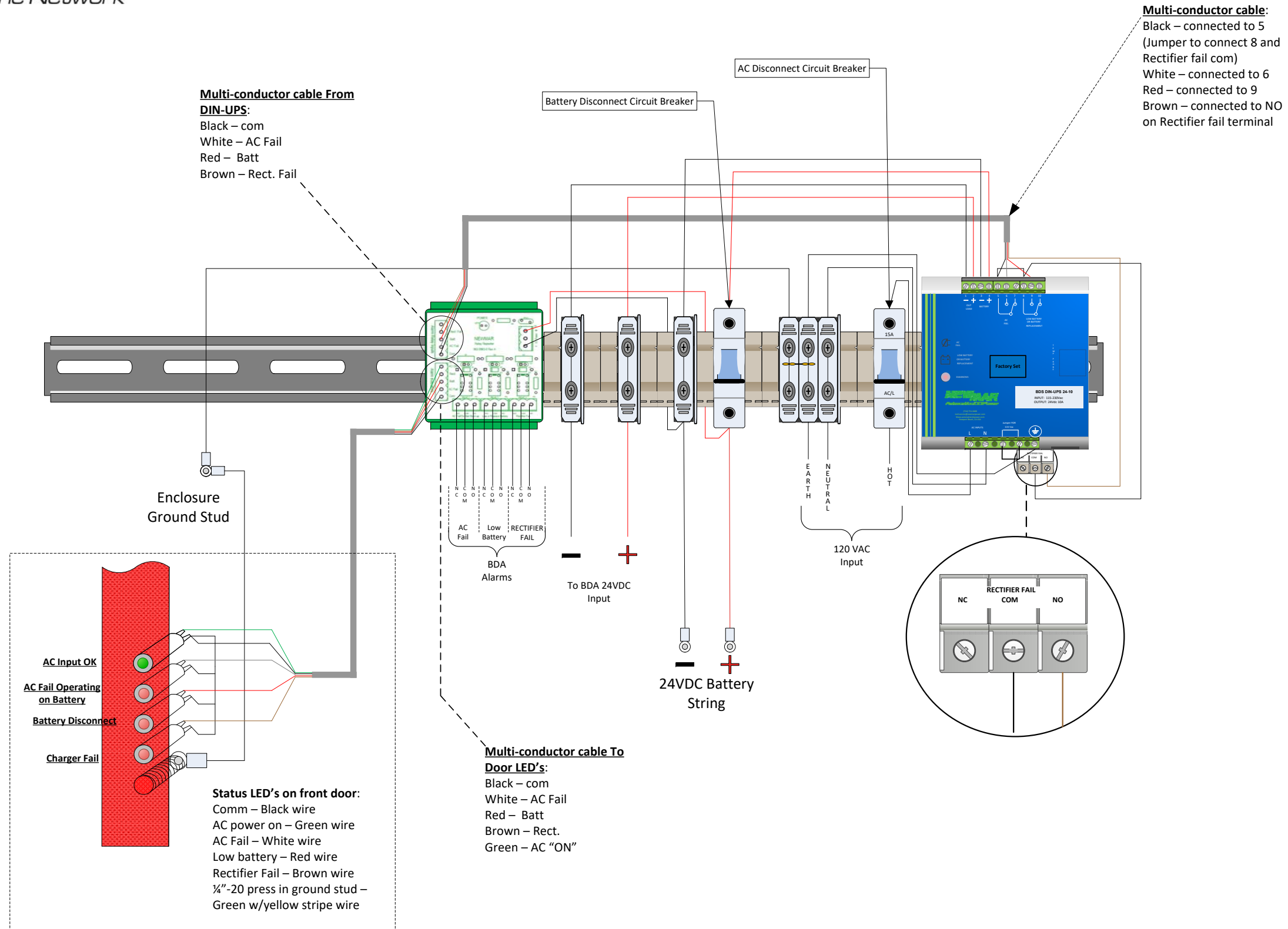

**\*Notes:**

1) BDS unit factory wired for **120** VAC Input

**Wiring Diagram:** PE-24V-240W-18AH/55AH/100AH-UL  
**Revision:** A  
**Drawn By:** R. Wirtz