



DIN Rail UPS

DC UPS/Battery Detection System Model: BDS-DIN-UPS 48-10 Installation/Operation Manual

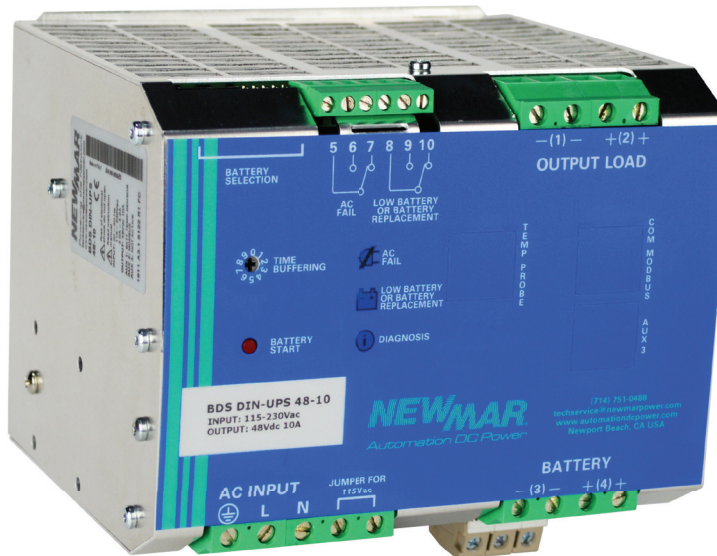

Table of Contents

Section	Page	Section	Page
Quick Start	2	4) Settings	7
1) General Information	4	A) Battery Type/Charge Curve	7
Materials Provided	4	B) Time Buffering/Battery Run Time	7
Optional Accessories	4	C) Load Priority Settings	8
2) Safety Information	4	5) Operation	8
3) Installation/Wiring	4	A) Battery Start w/o AC Present	8
A) Mounting	4	Push Button	
B) Wiring	5	B) Status Indicator LED's	8
1. AC Input	5	C) LVD	9
2. Output	5	6) Protection	9
C) Form C Contact	5	7) Specifications	10
D) Temperature Compensation Sensor	6	8) Troubleshooting	11
E) MODBUS	6	9) Warranty	11

M-BDSDINUPS4810-ULPE
AS OF 010318

Quick Start Guide

Figure 1: Quick Start

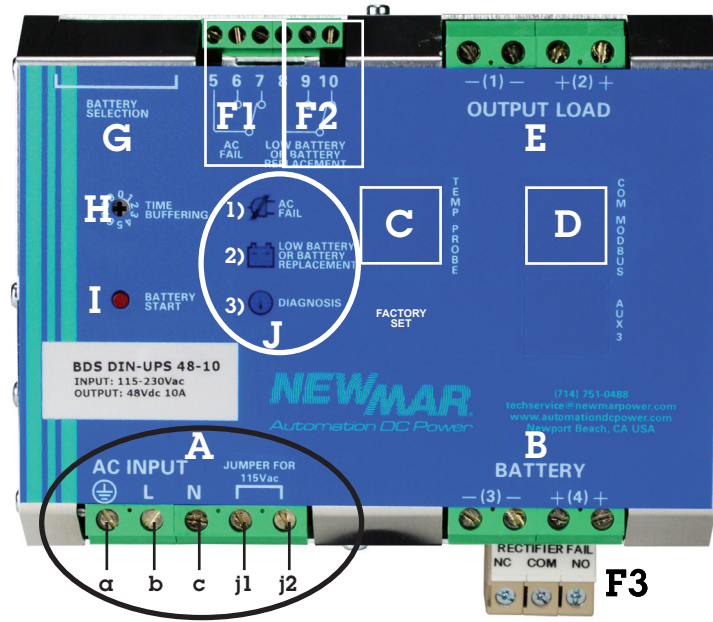

A) AC Input: Wire Input Block (lettered left to right)

- a) Earth Ground
- b) AC Hot 230 VAC: no jumper installed across j1 & j2
AC Hot 115 VAC: wire jumper across j1 and j2
- c) Neutral
- j1 & j2) Jumper these two inputs for 115 VAC operation
See page 5 for details.

B) Battery Output: two terminals each for plus and minus. Utilize dual wiring when battery location is more than 15 feet from unit. See page 5 for details.

C) Battery Temperature Sensor (optional): Plug in port (RJ-45). See page 6 for details.

D) Communication Modbus: See page 6 for more information.

E) Output to Load, two terminals each for plus and minus, utilize dual wiring when load is more than 15 feet from unit.

Note: the unit has a load priority circuit, all produced power is made available to the load, remaining power is available for battery charging. See page 5 for details.

F) Form C Contacts: Activate upon:

- F1.** AC Power Fail
- F2.** Low Battery (45.6V)
- F3.** Charger Power Circuit Fail
See page 5 for details.

G) System Settings: via plug-in jumper programming terminals located on top of the unit.

- a. Install jumper per illustration below (Table 1) to:
 - i. Select float voltage per Battery Type and enable Absorption Charge (see page 7 for details)
 - ii. Disable/Enable Load Priority (Functional Setting)
See page 8 for details on functional settings.

H) Time Buffering/Battery Run Time Settings: dial in time interval of desired run time of battery without disconnect.

- a. 1 - 60 minutes
or
- b. Set at zero for battery run until LVD activates @ 36.0 VDC (1.5 VPC)
See page 7 for details.

Mounting DIN DC UPS to DIN Rail

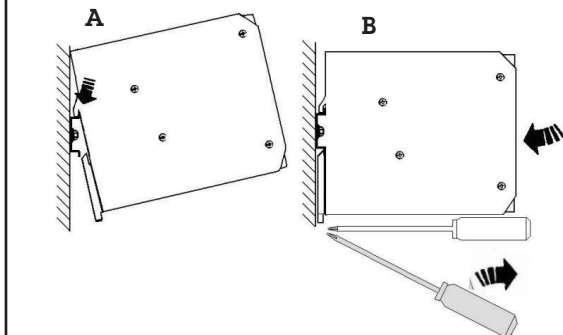

Removing DIN DC UPS from DIN Rail

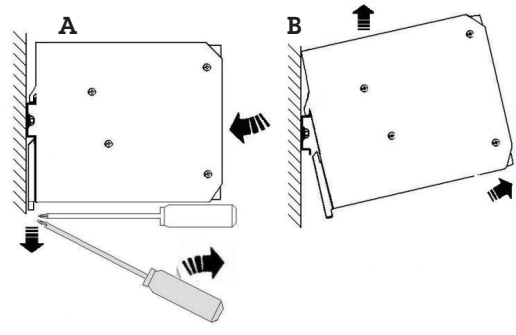

Insert screwdriver in slot of bottom tab and twist to extend bracket



D) Battery Start w/o AC Present Push Button:

- a. If system shuts down due to loss of AC and battery, power push button will allow battery to reconnect and supply the load if sufficient battery voltage is present.

J) Status Indicator LED's

- 1. AC Fail: Operating on battery back-up power (LED On). LED extinguishes when AC is present.
- 2. Low battery @ 70% discharge point, i.e. 30% capacity remains
- 3. Charger Output Status and Fault Mode Diagnosis: by blink code:

Charge Status Blink Code:

- Bulk: 5 blink/second - Recovery
- Absorption: 2 blink/second - Bulk
- Float: 1 blink/second

Fault Mode Diagnosis Blink Code:

- Reverse Polarity: 1 blink, pause
- Battery Not Connected: 2 blink, pause
- Overload or Short Circuit: 4 blink, pause
- Low Battery (steady on): 5 blink, pause
- Bad Thermal Sensor: 7 blink, pause and diagnostic

See page 8 for details.

Table 1: System Settings: Battery Selection/Absorption Charge

Note: voltages above are at 20° C with no battery temp. sensor connected.

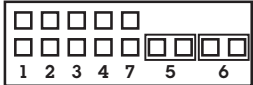
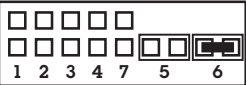
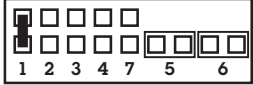
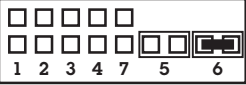
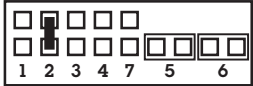
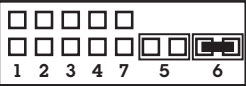
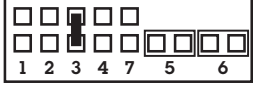
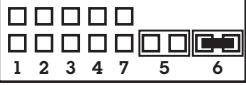
Battery Type Selection	Float Charge/ Jumper Insert Position	Absorption Charge Enable/ Jumper Insert Position
Open Lead (Default)	 None 53.52 VDC	 Pos. 6 57.6 VDC
Sealed Lead Insert Jumper: Pos. 1	 Pos. 1 54.0VDC	 Pos. 6 57.6 VDC
Gel Battery Insert Jumper: Pos. 2	 Pos. 2 55.2 VDC	 Pos. 6 57.6 VDC
Ni-Cad Insert Jumper: Pos. 3	 Pos. 3 56.0 VDC (1.4 VPC x 40 Cells)	 Pos. 6 60.0 VDC (1.5 VPC x 40 Cells)

Absorption Charge: Unit outputs 58.4 VDC for two minutes, then output is reduced to 57.6 VDC

Note: Don't use Ni-Cad charging on battery less than 7 AH.

Table 2: System Settings: Functional Settings

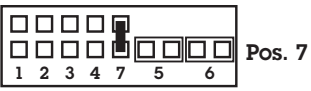
Function Setting		
Load Priority Disable (Makes full power available for charging) Insert Jumper: Pos. 7		Jumper inserted into position 7 making all power from the unit available for battery charging by disabling the load priority output function. Under low battery charge condition, output voltage to load will be equal to that of the battery voltage, thus useful voltage to the load will not be available until the battery recovers to proper levels.

1) General Information

This DIN rail mount DC UPS Combines all system power functions: power supply, battery charger, UPS circuitry and status monitoring in one compact unit that produces 48 volt, 10 amps allocated via dual outputs for load and battery:

- Load output: "load priority" distribution ensures power is dedicated first to the load, with remainder then allocated to battery charging, thus preventing a discharged battery from impacting operation of critical loads.
- Battery output: 3 step charging for rapid battery recovery, programmable for battery type, with optional temperature compensation sensor
- Battery automatically on line to support load anytime AC fails
- Low voltage disconnect protects battery from total discharge
- High operating temperature range to 70° C

This DC UPS is fitted with special monitoring and alarm features designed to comply with the latest codes related to public safety in-building wireless communications back-up power requirements, as set forth by NFPA, section 1221.

In normal operation, the unit supplies power to the transmitter/antennas and maintains the back-up battery. Should an event occur that could cause interruption in power, self-diagnosis signals are sent via form C contacts notifying the network operators the system is running in a critical power condition and that potential communications failure is imminent.

- 1) AC Fail
- 2) Low battery voltage indicating battery discharged by 70% (i.e. 30% capacity remaining)
- 3) Internal charger/power circuit fail

Materials Provided:

- 1 ea. BDS-DIN-UPS unit with integral DIN rail mount clip
- 4 ea. Jumper tabs for programming
- 1 ea. Jumper wire (orange) for 115 volt input operation

Optional Equipment:

Temperature Compensation Sensor, P/N: 468-4510-0

2) Safety Information



WARNING – Explosion Hazard. Do not disconnect loads or battery unless AC input and battery have been switched off.

WARNING – Explosion Hazard. This product is not certified for Class 1, Div 2 applications.

WARNING – Switch off or remove AC input and battery power before wiring the BDS-DIN-UPS-48-10. Never work on the DIN UPS when it is connected to AC input and battery. The DIN UPS must be installed in accordance with UL508 or local electrical codes depending upon the application. The DIN UPS should have a suitability sized AC input circuit breaker feeding its AC input. See specification section for maximum AC input draw for your input voltage for circuit breaker sizing.

CAUTION: Hot surface. Avoid touching the DIN UPS case while operating at or near its full load capacity. Remove AC and battery power and allow DIN UPS at least 10 minutes to cool before removing from DIN Rail.

3) Installation/Wiring

A) Mounting:

The unit is designed for 35 mm DIN rail mounting in an enclosure and relies on convection (free air) cooling, thus must have a minimum vertical and horizontal distance to adjacent surface of 4" (10 cm) to this power supply in order to assure sufficient air flow. We recommend approximately 1/2" (10mm) spacing between adjacent DIN Rail mounted devices. Note, that depending on the ambient temperature and load of the device, the temperature of the case can become hot to the touch.

The unit is designed for vertical mount (+/- 5°) and has an integral clip on the back to secure it to the rail. To mount, place

the top tabs over the top of the DIN rail, and using a long slotted screw driver insert it in the groove at the bottom of the bracket and twist which will extend the spring loaded mounting bracket downward allowing the unit to be positioned against the DIN rail, release the bracket with DIN UPS positioned vertically and the rail will be captured and the unit secured.

Figure 2: Mounting

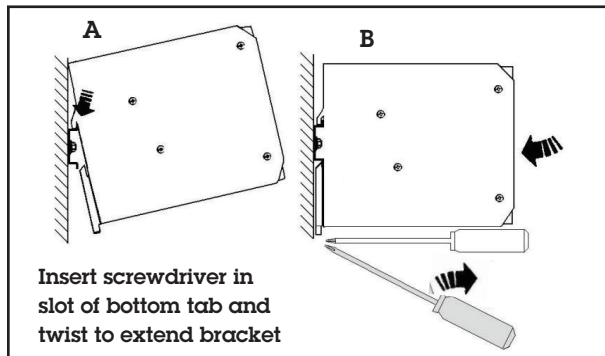
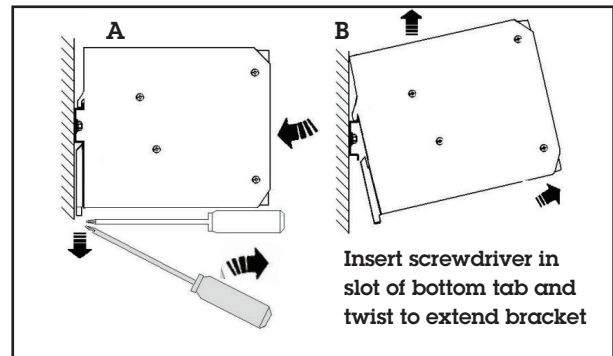

Figure 3: Removing



B) Wiring

1. AC Input: Terminal Block (lettered left to right) - Figure 4

- a) Earth Ground
- b) AC Hot (note: install jumper provided across terminals j1 and j2 for 115 VAC input)
- c) Neutral
- j1 & j2) Jumper these two terminals for 115 VAC operation and apply 115V hot to term b and neutral to c

Recommended wire size: 16 AWG

2. Output

The unit has dual output circuits: one for connection to the Load, the other to the back-up battery. Note: the unit has a load priority circuit, all produced power first is made available to the load with remaining power made available for battery charging. Both outputs are isolated from the case thus you may apply to a positive or negative ground system. Note however, the LVD circuit is in the positive side thus this feature will not function in -48VDC positive ground application utilizing a common positive ground bus bar for battery and load.

Battery Output: two sets of terminals each for plus and minus. Utilize dual wiring when battery location is more than 15 feet from unit to minimize voltage drop. See page 3, Section G for programming per battery type.

Output to Load: two terminals each for plus and minus, utilize dual wiring when load is more than 15 feet from unit to minimize voltage drop.

Fuse note: We recommend a 15 amp fuse be installed on the hot leg at battery. If using both sets of battery terminals on DIN UPS (i.e. two pairs of wires), connect both hot wires to one side of battery fuse.

Battery/Output wires size (recommended): 16 AWG
Terminal Block maximum wire size (recommended): 10 AWG

C) Alarm Contacts, Form C (Isolated):

Form C Contacts for remote monitor: Activate upon:

- a. AC Power Fail
- b. Low Battery, 45.6V DC - @ 70% Discharge Point*, i.e. 30% capacity remains
- c. Charger/Power Circuit fail

* Applicable to battery systems with 2 - 5 amp continuous load with 100 - 150 AH capacity

Figure 4: AC Input Terminal Block

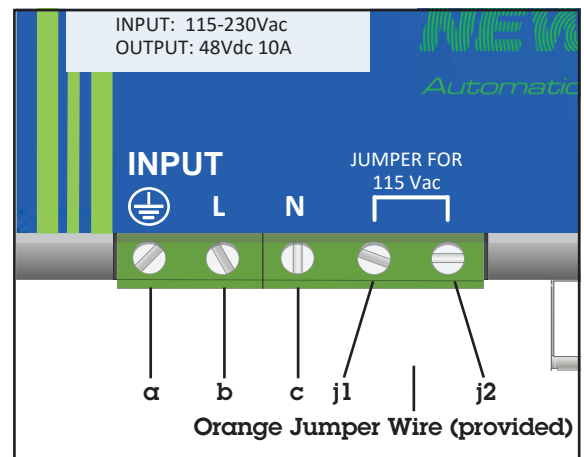

Figure 5: Output Terminals

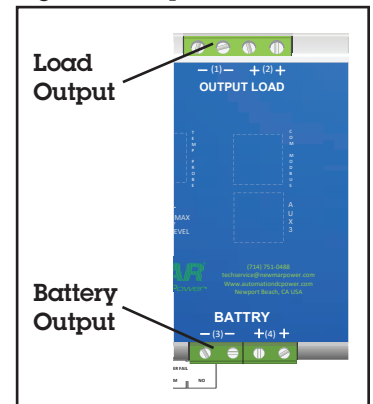
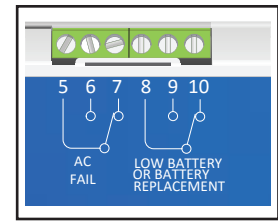

Table 2: Alarm Contacts

Input	Contact				1 AC Fail LED	2 Low Battery* LED	3 Diagnosis LED
	5-6	5-7	8-9	8-10			
AC only	closed	open	open	closed	off	on	2 Blink-Pruse
AC + Batt	closed	open	closed	open	off	off	1 Blink/sec
Batt only	open	closed	closed	open	on	off	off
Low Batt	open	closed	open	closed	on	on	off

* Labeled Low Battery or Battery Replacement on Front Panel

Figure 6: Alarm Contacts Terminals, Form C (Isolated)



Relay Contact Rating:

Max. DC: 30 VDC, 1 amp; AC: 60 VAC, 1 amp; Resistive load (EN 60947-4-1)
Min. 1mA at 5 VDC

D) Optional Battery Temperature Compensation Sensor P/N: 468-4510-0

To install, remove the access tab in the front panel decal labeled AUX 1, install the Temp. Sensor into the RJ-45 connector. Attach sensor to side of battery using RTV silicone.

The sensor will vary the battery charging voltage depending on the battery's temperature and charge program setting.

Figure 7: Charger/Power Circuit Fail Alarm Contacts

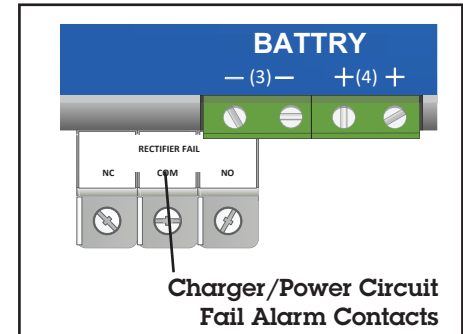
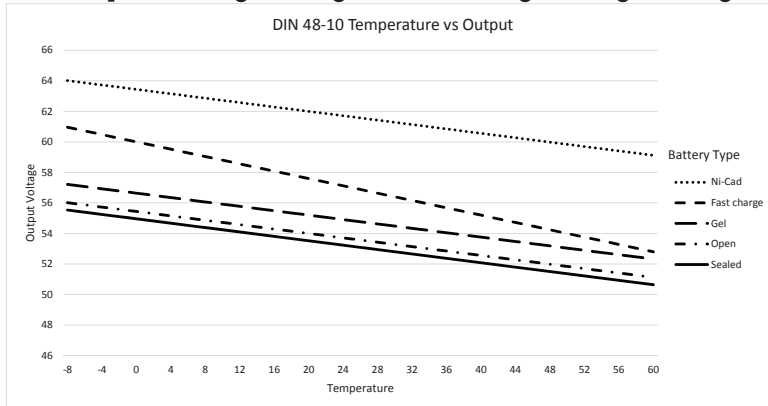

Table 3: Absorption Charge Voltage & Float Charge Voltage Settings



Float Voltage = Voltage @ 20° C - (Sensor Temp ° - 20°) x .003 x number of cells)
Fast Charge = Voltage @ 20° C - (Sensor Temp ° - 20°) x .005 x number of cells)
Eg. Sensor Temp = 60°
Voltage @ 20° = 53.5V
Battery Cells = 24 (Ni-Cad = 40 cells)
Float: 50.64V = 53.5V - (40 x .003 x 24)

If the battery temperature is less than -20° C or greater than +60° C, an 'outside its range (temp. sensor)' alarm is signalled with code 7 blink.

If the sensor is not connected or if the sensor is defective, the LED Low Batt will illuminate and the LED Diagnosis' LED continues to show the status of the battery, i.e., trickle charge, fast charge or recovery charge.

E. Optional MODBUS: The BDS-DIN-UPS-48-10 incorporates MODBUS communication protocol over RS-485 serial interface. For details on MODBUS feature and to obtain the MAP file please go to www.poweringthenetwork.com/din-ups/ and download the DIN-UPS-48-10 MODBUS Application Note. To connect to the DIN-UPS 48-10 MODBUS serial port remove the access tab in the front panel decal labeled AUX 2, see Figure 9.

Figure 8 & 13: Status Indicator LEDs

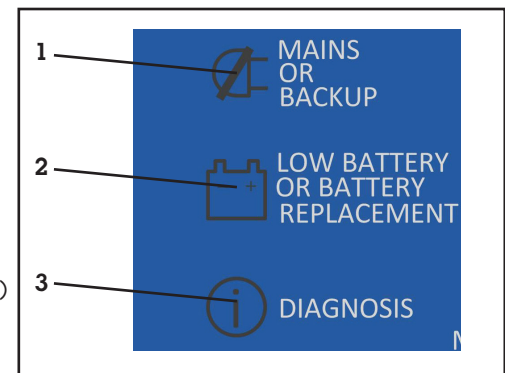
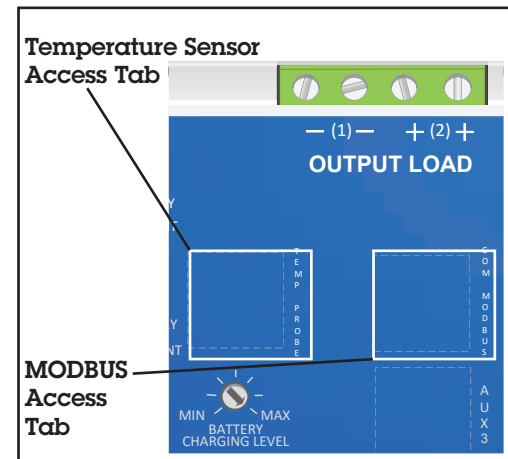

Figure 9: Battery Temperature Sensor & MODBUS Access Tabs



4) Settings

A) Battery Type/Charge Curve

Charge curve per battery type: via programming jumpers on top panel of unit left side.

Using programming jumper tabs provided and a small needle nose pliers, insert programming jumpers to select float voltage and enable absorption voltage per per battery type. Caution do not program unit while connected to power.

Figure 10: Battery Type

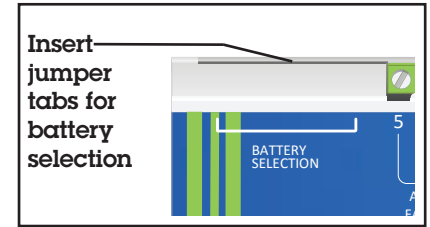

Table 4: Battery Selection/Absorption Charge

Battery Type Selection	Float Charge/ Jumper Insert Position	Absorption Charge Enable/ Jumper Insert Position
Open Lead (Default)	<p>None</p> <p>53.52 VDC</p>	<p>Pos. 6</p> <p>57.6 VDC</p>
Sealed Lead Insert Jumper: Pos. 1	<p>Pos. 1</p> <p>54.0VDC</p>	<p>Pos. 6</p> <p>57.6 VDC</p>
Gel Battery Insert Jumper: Pos. 2	<p>Pos. 2</p> <p>55.2 VDC</p>	<p>Pos. 6</p> <p>57.6 VDC</p>
Ni-Cad Insert Jumper: Pos. 3	<p>Pos. 3</p> <p>56.0 VDC (1.4 VPC x 40 Cells)</p>	<p>Pos. 6</p> <p>60.0 VDC (1.5 VPC x 40 Cells)</p>

Absorption Charge: Unit outputs 58.4 VDC for two minutes, then output is reduced to 57.6 VDC

Note: Don't use Ni-Cad charging on battery less than 7 AH.

B) Time Buffering/Battery Run Time

This function determines how long the reserve battery will power the system in the event of AC failure. You may choose a specified time or run until the LVD activates.

Settings: dial in time interval of desired run time of battery without disconnect. Using small screw driver to set the dial arrow to the desired setting:

- a. 1 - 60 minutes
- or
- b. Set at zero for battery run until LVD activates @ 36.0 VDC (1.5 VPC)

Figure 11: Time Buffering/Battery Run Time - Dial

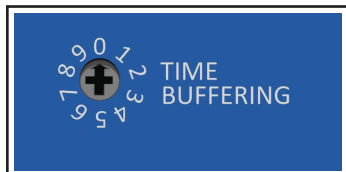

c) Load Priority Setting

Via plug-in jumper programming terminals located on top of the unit. Install jumper per illustration below to:

- i. Disable/Enable Load Priority - factory default Load Priority enabled: jumper not installed

Table 5: Function Settings

Function Setting		
Load Priority Disable (Makes full power available for charging) Insert Jumper: Pos. 7		Pos. 7 Jumper inserted into position 7 making all power from the unit available for battery charging by disabling the load priority output function. Under low battery charge condition, output voltage to load will be equal to that of the battery voltage, thus useful voltage to the load will not be available until the battery recovers to proper levels.

5) Operation

A) Battery Start without AC Present Push Button:

If system shuts down due to loss of AC and battery power, pushing button will allow battery to come on line to supply the load. Press and hold for 3 seconds to re-connect battery to output. Note, if LVD has activated and battery voltage has not recovered above disconnect point, the unit will not cycle on.

B) Status Indicator LED's

1. Power source: Mains or back up
 - i. AC OK (LED Off)
 - or
AC Fail
 - ii. Operating on battery backup power (LED On) red
2. Low battery

Figure 12: Battery Start LED

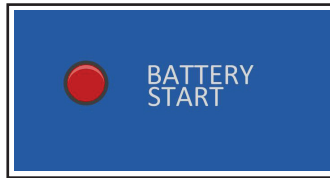
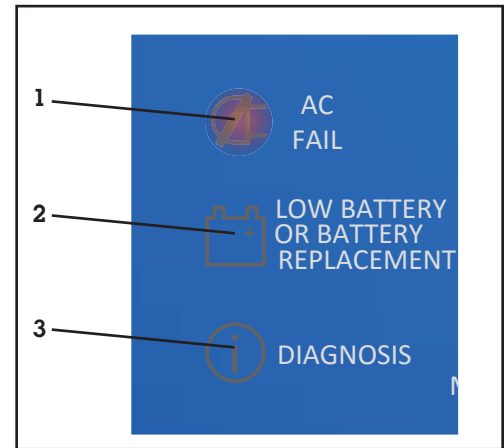

Figure 13: Status Indicator LEDs











LED illuminates when:

- Low Battery ~ 70% depleted (45.6V), i.e. 30% capacity remains

3. Diagnosis LED.

Charger output status system diagnosis and Fault mode diagnosis: by blink code (Table 6 on next page).

Table 6: Status Indicator LEDs

Monitoring Control	State	LED Diagnosis (No.8)	LED Battery Fault No.7)
Charging Type	Float	1 Blink/sec	OFF
	Absorption	2 Blink/sec	OFF
	Bulk	5 Blink/sec	OFF
System Auto Diagnosis	Reverse polarity or high battery Voltage	1 Blink/pause* 	ON
	Battery Not connected, no output power	2 Blink/pause 	ON
	Over Load or short circuit on the load	4 Blink/pause 	ON
	Low battery: 45.6 volts	5 Blink/pause 	ON
	Battery Life Test Not Possible	6 Blink/pause 	ON
	Temp. Sensor outside its range	7 Blink/pause 	ON
	Boost condition; battery discharge after 4 min. of overload.	8 Blink/pause 	ON
	Internal fault	9 Blink/pause 	ON
	Low battery detected when system activated by battery start button with no ac input	10 Blink/pause 	ON
	* Pause: 1 Second		

C) LVD

The unit contains a low voltage load disconnect that activates at 36 volts (1.5 vpc) which is factory set and cannot be user modified.

Note that when wired to positive ground applications the LVD function does not operate. (See also Section 4-C regarding operation with battery time out circuit)

6) Protection

On the AC Input: the device is equipped with an internal fuse. If the internal fuse is blown, it is most probable that there is a fault in the unit. If this occurs, the unit must be returned to the factory.

On the DC Output Battery and Load: The device is electronically protected.

Reverse polarity: the module is automatically protected against reverse of battery polarity and connection of reverse polarity.

Over current and output short circuit: the unit limits the output current. Low voltage disconnect protects battery from deep discharge.

Thermal Protection

Operating temperature range -12 to 70° C. Unit will produce full rated power on continuous basis to 50° C, however; system load must be reduced by 2.5% per 1° for continuous operation above 50° C. If the temperature reaches 70° C, the unit will reduce its maximum output to approximately 50% of its rating. If the temperature exceeds 70° C, the unit will shut off and restart once temperature drops.

7) Specifications

Input:

Voltage: 90-135/ 180-305 47-63 hz

Amperage: 8 @ 120 VAC / 4.2 @ 230 VAC

Output: 48 volts, 10 amps total available to power loads and charge battery, with load priority distribution.

Peak: 30 amps 4 seconds (with battery power boost)

Output ground isolated from case, may be used in positive ground applications. LVD function is lost

Front Panel LED Indicators:

- Power Source: operating on back up – red LED
- Battery and System Diagnostics (via blink code)

Settings/Selectors:

- Battery Type: AGM, Sealed Lead Acid, Gel-Cell, Ni-Cad (40 cell)

Battery Charge Current Limit: 20 - 100% of charge
amperage rating

Back-Up Run Time on Batteries:

- Programmed time limit: 1 - 60 min.
Or

- Until LVD disconnect @ 36V

Power Restore Button: connects battery without AC present

Alarm Contacts (form C): Active:

- AC Fail
- Low Battery 45.6V DC: indicating 70% battery discharge point (i.e. 30% capacity remains based on 2 - 5 amp continuous load on 100 -150 AH battery)
- Charger/Power Circuit Failure

Operating Temperature: -12 to 70° C. Continuous to 50°, de-rate 2.5% per° C >50° C

Cooling: Free air convection

Efficiency: 91%

Humidity: to 95%, to 25° C

Power Discipation (max.): 54 Watts

BTU's: 185

Protection:

- Low Voltage disconnect at 1.5 volts per cell (36 VDC)
- Internal fuse
- Current limiting
- Short circuit
- Reverse polarity
- Thermal overload shut down and recovery
- IP 20
- Designed to UL 1950

Terminal Blocks: Screw type

Mounting: DIN Rail Bracket 35 mm

Auxiliary Jacks

- **AUX 1:** Battery Temperature Compensation via optional Battery Temp. Sensor, P/N 468-4510-0, with RJ-45 connector
- **AUX 2:** MODBUS Communication via RS-485 serial interface

8) Troubleshooting

Symptom	Possible Cause	Corrective Action	Section
A. Battery requires excessive re-charge time	<ol style="list-style-type: none"> 1. Load at or near max. recommended load providing minimal current available for charging 2. Charging level current set to low 	<ol style="list-style-type: none"> 1. Reduce load or split load between two separate DIN UPS units 2. Adjust "Battery Charging Level" control knob to higher level 	
B. Load turns off after a couple of seconds when running on battery	<ol style="list-style-type: none"> 1. Time buffer set to incorrect position 2. Batteries not charged, due to high load demand 	<ol style="list-style-type: none"> 1. Verify correct setting with manual 2. Reduce load or split load between two separate DIN UPS units 	
C. No absorption voltage	<ol style="list-style-type: none"> 1. Absorption jumper not installed 	<ol style="list-style-type: none"> 1. Install provided jumper in position 6 	
D. Unit does not turn on	<ol style="list-style-type: none"> 1. AC input is 115 VAC, no jumper wire installed 	<ol style="list-style-type: none"> 1. Install 115V jumper wire across j1 and j2 	
E. Trips AC input breaker	<ol style="list-style-type: none"> 1. AC shorted to case 2. Defective unit 	<ol style="list-style-type: none"> 1. Verify correct AC input wiring 2. Contact technical service 	
F. No output	<ol style="list-style-type: none"> 1. DC output wired backwards or shorted 2. No AC input 3. Excessive temperature or blocked ventilation 4. Defective unit 	<ol style="list-style-type: none"> 1. Remove AC input and check DC wiring 2. Verify correct AC input and jumper wire installed if powering from 115 VAC 3. Improve ventilation, unblock vent holes 4. Contact technical service 	
G. No voltage on battery output terminals	<ol style="list-style-type: none"> 1. No battery installed (voltage required for battery output to turn on) 2. Missing or blown battery wiring fuse 	<ol style="list-style-type: none"> 1. Install batteries 2. Replace missing or blown battery wiring fuse 	
H. Diagnosis LEDs always blinking	<ol style="list-style-type: none"> 1. Normal operation 	<ol style="list-style-type: none"> 1. Refer to Chart 2: Diagnosis Table 	

9) Warranty

Newmar warrants that the BDS-DIN-UPS 48-10 DIN Rail UPS to be free from defects in material and workmanship for two years from date of purchase. If a problem with your BDS-DIN-UPS 48-10, or if you have any questions about the installation and proper operation of the unit, please contact NEWMAR's Technical Services Department:

Phone: 714-751-0488 - From the hours of 7:30 a.m. to 5:00 p.m. weekdays, P.S.T. ;
 Fax: 714-372-7930
 E-mail: techservice@newmarpower.com