



DIN Rail UPS

Model: DIN-UPS 24-20

Installation/Operation Manual

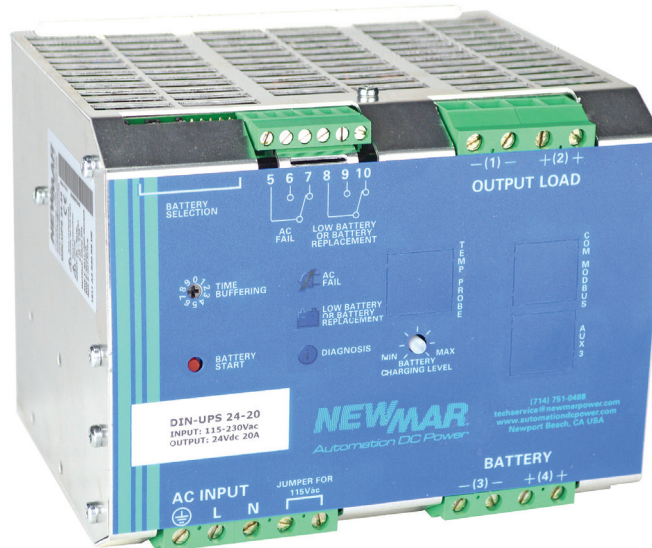

Table of Contents

Section	Page	Section	Page
Quick Start	2	A) Battery Type/Charge Curve	6
1) General Information	4	B) Time Charge Current Limit/Battery Charge Level	7
Materials Provided	4	C) Time Buffering/Battery Run Time	8
Optional Accessories	4	D) System Settings	8
2) Safety Information	4	5) Operation	8
3) Installation/Wiring	4	A) Battery Start w/o AC Present Push Button	8
A) Mounting	4	B) Status Indicator LED's	8
B) Wiring	5	C) LVD	9
1. AC Input	5	6) Protection	9
2. Output	5	7) Specifications	10
C) Form C Contact	5	8) Troubleshooting	11
D) Temperature Compensation Sensor	6	9) Warranty	11
4) Settings	6		

M-DINUPS2420AS
OF 012216



Automation DC Power • Powering the Network

www.Newmarpower.com

Phone: 714-751-0488

Fax: 714-957-1621

E-Mail: techservice@newmarpower.com

Quick Start Guide

Figure 1: Quick Start

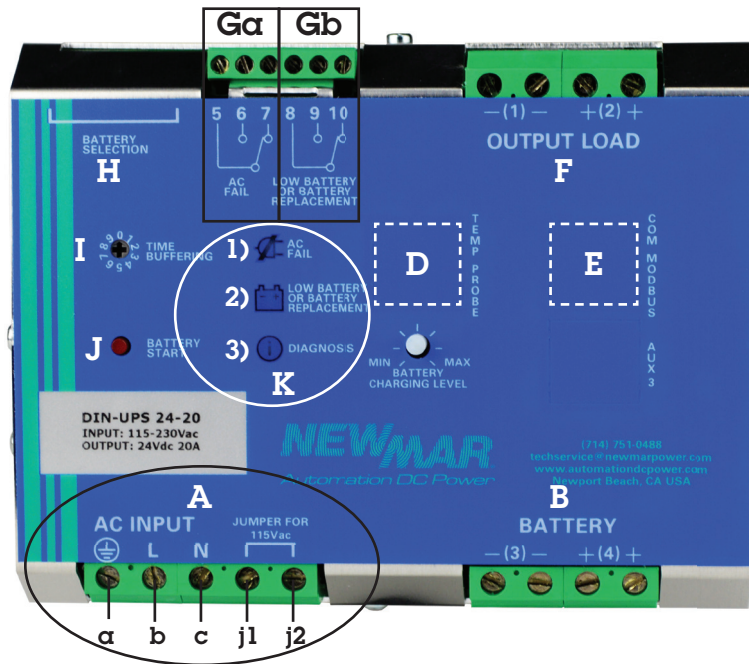

A) AC Input: Wire Input Block (lettered left to right)

- a) Earth Ground
- b) AC Hot 230 VAC: no jumper installed across j1 & j2
AC Hot 115 VAC: wire jumper across j1 and j2
- c) Neutral
- j1 & j2) Jumper these two inputs for 115 VAC operation
See page 5 for details.

B) Battery Output: two terminals each for plus and minus. Utilize dual wiring when battery location is more than 15 feet from unit. See page 5 for details.

C) Battery Charge Current Limit: Allows setting maximum current flow to battery during recharge cycle, use when low amp-hour batteries are applied to system to prevent overheating when recovering dead batteries. Adjustment range 20-100% of available charge current. (Available charge current = unit output rating of 10 amps - load demand. Note: the unit has a load priority circuit, all produced power is made available to the load, remaining power is available for battery charging). See page 6 for details.

D) Battery Temperature Sensor (optional): Plug in port (RJ-45). See page 6 for details.

E) Communication Modbus: contact factory for more information

F) Output to Load, two terminals each for plus and minus, utilize dual wiring when load is more than 15 feet from unit. **Note:** the unit has a load priority circuit, all produced power is made available to the load, remaining power is available for battery charging. See page 5 for details.

G) Form C Contacts: Activate upon:

- a. AC power fail
 - b. Low battery or poor battery condition
- See page 5 for details.

H) System Settings: via plug-in jumper programming terminals located on top of the unit.

- a. Install jumper per illustration below (Table 1) to:
 - i. Select float voltage per Battery Type and enable Absorption Charge (see page 7 for details)
 - ii. Enable Battery Test (Functional Setting)
 - iii. Disable/Enable Load Priority (Functional Setting)
- See page 8 for details on functional settings.

Mounting DIN DC UPS to DIN Rail

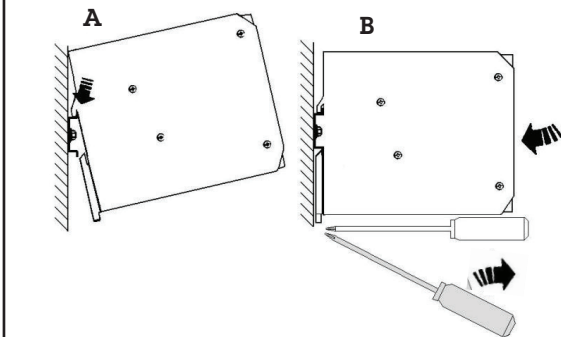

Insert screwdriver in slot of bottom tab and twist to extend bracket

Removing DIN DC UPS from DIN Rail

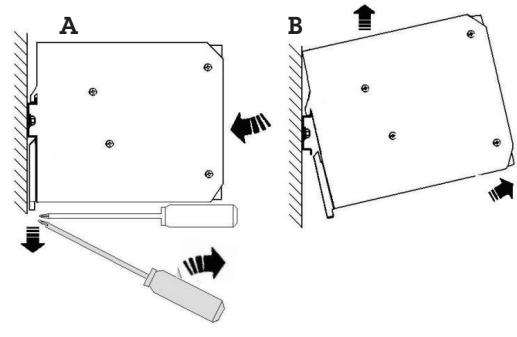

I) Time Buffering/Battery Run Time Settings: dial in time interval of desired run time of battery without disconnect.

a. 1 - 60 minutes

or

b. Set at zero for battery run until LVD activates

@ 18 VDC (1.5 VPC)

See page 7 for details.

J) Battery Start w/o AC Present Push Button:

a. If system shuts down due to loss of AC and battery, power push button will allow battery to reconnect and supply the load if sufficient battery voltage is present.

K) Status Indicator LED's

1. AC Fail: Operating on battery back-up power (LED On). LED extinguishes when AC is present.
2. Low battery, or poor battery condition
3. Charger Output Status and Fault Mode Diagnosis: by blink code:

Charge Status Blink Code:





- Bulk: 5 blink/second - Recovery
- Absorption: 2 blink/second - Bulk
- Float: 1 blink/second

Fault Mode Diagnosis Blink Code:

- Reverse Polarity: 1 blink, pause
 - Battery Not Connected: 2 blink, pause
 - Overload or Short Circuit: 4 blink, pause
 - Bad Battery Wire Connection, or Bad Battery (internal impedance): 5 blink, pause
 - Bad Thermal Sensor: 7 blink, pause and diagnostic
- See page 8 for details.

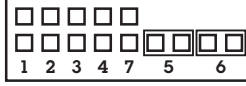
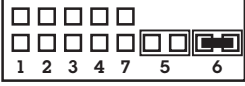
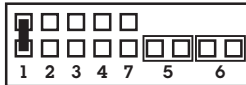
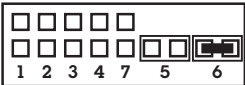
Table 1: System Settings: Battery Selection/Absorption Charge

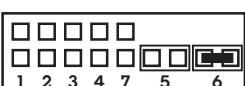
Note: voltages above are at 20° C with no battery temp. sensor connected.

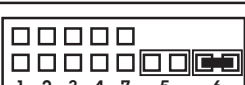
Battery Type Selection	Float Charge/ Jumper Insert Position	Absorption Charge Enable/ Jumper Insert Position
Open Lead (Default)	 None 26.76 VDC	 Pos. 6 28.8 VDC
Sealed Lead Insert Jumper: Pos. 1	 Pos. 1 27.0 VDC	 Pos. 6 28.8 VDC
Gel Battery Insert Jumper: Pos. 2	 Pos. 2 27.6 VDC	 Pos. 6 28.8 VDC
Ni-Cad Insert Jumper: Pos. 3	 Pos. 3 *See note below	 Pos. 6 31.0 VDC (1.55 VPC x 20 Cells)

Absorption Charge: Unit outputs 29.2 VDC for two minutes, then output is reduced to 28.8 VDC

***NiCad Battery Charge Parameters**

Caution! When configuring for NiCad use, the Battery Charging Level adjustment on front panel must be set to at least 30% of the capacity of the battery being charged (ie at least 30% of battery rated Amp-Hour capacity). (Note, the adjustment range of Battery Charging Level dial on the unit is 4 amps minimum, 20 amps maximum.)

If set below the prescribed 30% minimum Ah capacity, the control circuit may not be able to sense battery absorption rate, and thus not terminate absorption charge cycle until 16 hours has passed, potentially resulting in battery over-charge.

Float Charge: Constant current, rate =10% of the set Battery Charging Level

Absorption Charge: 31.0 VDC (1.55 VPC x 20 cells).

Termination of absorption charge is determined by an automatic battery test applied after entering absorption mode:

- If test indicates battery will not maintain its voltage (ie drops by > 0.1 volts) absorption mode will continue for a maximum 16 hours before reverting to float mode.
- If test indicates battery voltage is maintained (i.e. drops <0.1 volts), absorption mode times out after 10 minutes, and reverts to float mode.



Table 2: System Settings: Functional Settings

Function Setting		
Battery Test ON Insert Jumper: Pos. 4		Pos. 4 Insert jumper at position 4 to enable Periodic Battery condition test process. (Fault reported by LED diagnosis blink code, see Table 6): <ul style="list-style-type: none"> ▪ Battery wiring connection ▪ Battery efficiency/sulfation (impedance test) ▪ Shorted Cell
Load Priority Disable (Makes full power available for charging) Insert Jumper: Pos. 7		Pos. 7 Jumper inserted into position 7 making all power from the unit available for battery charging by disabling the load priority output function. Under low battery charge condition, output voltage to load will be equal to that of the battery voltage, thus useful voltage to the load will not be available until the battery recovers to proper levels.

1) General Information

This DIN rail mount DC UPS Combines all system power functions: power supply, battery charger, UPS circuitry and status monitoring in one compact unit that produces 24 volt, 20 amps allocated via dual outputs for load and battery:

- Load output: "load priority" distribution ensures power is dedicated first to the load, with remainder then allocated to battery charging, thus preventing a discharged battery from impacting operation of critical loads.
- Battery output: 3 step charging for rapid battery recovery, programmable for battery type, with optional temperature compensation sensor
- Battery automatically on line to support load anytime AC fails
- Low voltage disconnect protects battery from total discharge
- Automatic periodic battery health diagnosis
- High operating temperature range to 70° C
- Alarm contacts: AC fail, battery status/condition

Materials Provided:

- 1 ea. DIN-UPS unit with integral DIN rail mount clip
- 4 ea. Jumper tabs for programming
- 1 ea. Jumper wire (orange) for 115 volt input operation

Optional Equipment:

Temperature Compensation Sensor, P/N: 468-4510-0

2) Safety Information



WARNING – Explosion Hazard. Do not disconnect loads or battery unless AC input and battery have been switched off.

WARNING – Explosion Hazard. Substitution of components may impair suitability for class I, Division 2.

WARNING – Switch off or remove AC input and battery power before wiring the DIN-UPS 24-20. Never work on the DIN UPS when it is connected to AC input and battery. The DIN UPS must be installed in accordance with UL508 or local electrical codes depending upon the application. The DIN UPS should have a suitability sized AC input circuit breaker feeding its AC input. See specification section for maximum AC input draw for your input voltage for circuit breaker sizing.

CAUTION: Hot surface. Avoid touching the DIN UPS case while operating at or near its full load capacity. Remove AC and battery power and allow DIN UPS at least 10 minutes to cool before removing from DIN Rail.

3) Installation/Wiring

A) Mounting:

The unit is designed for 35 mm DIN rail mounting in an enclosure and relies on convection (free air) cooling, thus must have a minimum 4" (10 cm) of open space above and below DIN UPS in order to assure sufficient air flow. We recommend approximately 1/2" (10mm) spacing between adjacent DIN Rail mounted devices. Note, that depending on the ambient temperature and load of the device, the temperature of the case can become hot to the touch.

The unit is designed for vertical mount (+/- 5°) and has an integral clip on the back to secure it to the rail. To mount, place the top tabs over the top of the DIN rail, and using a long slotted screw driver insert it in the groove at the bottom of the bracket and twist which will extend the spring loaded mounting bracket downward allowing the unit to be positioned against the DIN rail, release the bracket with DIN UPS positioned vertically and the rail will be captured and the unit secured.



Figure 2: Mounting

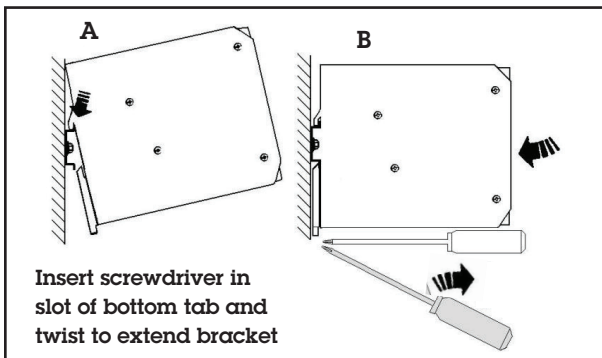
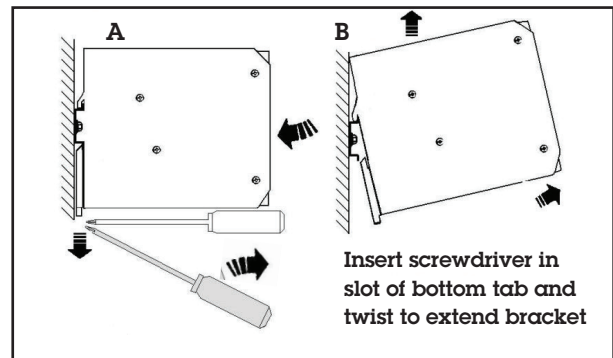

Figure 3: Removing



B) Wiring

1. AC Input: Terminal Block (lettered left to right) - Figure 4

- a) Earth Ground
- b) AC Hot (note: install jumper provided across terminals j1 and j2 for 115 VAC input)
- c) Neutral
- j1 & j2) Jumper these two terminals for 115 VAC operation and apply 115V hot to term b and neutral to c

Recommended wire size: 16 AWG

2. Output

The unit has dual output circuits: one for connection to the Load, the other to the back-up battery. Note: the unit has a load priority circuit, all produced power first is made available to the load with remaining power made available for battery charging. Both outputs are isolated from the case.

Battery Output: two sets of terminals each for plus and minus. Utilize dual wiring when battery location is more than 15 feet from unit to minimize voltage drop. See page 2 and 3, Section H for programming per battery type.

Output to Load: two terminals each for plus and minus, utilize dual wiring when load is more than 15 feet from unit to minimize voltage drop.

Fuse note: We recommend a 25 amp fuse be installed on the hot leg at battery. If using both sets of battery terminals on DIN UPS (i.e. two pairs of wires, recommended for long wire runs), connect both hot wires to one side of battery fuse.

Battery/Output wires size (recommended): 14 AWG

Terminal Block maximum wire size (recommended): 10 AWG

C) Alarm Contacts, Form C (Isolated):

Form C Contacts for remote monitor: Activate upon:

- a. AC power fail
- b. Low battery, or poor battery condition

Figure 4: AC Input Terminal Block

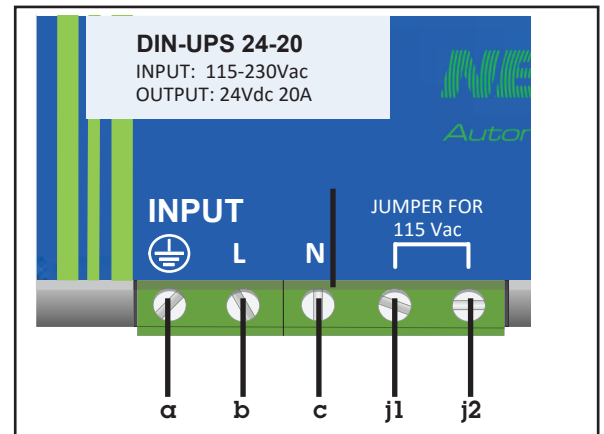

Figure 5: Output Terminals

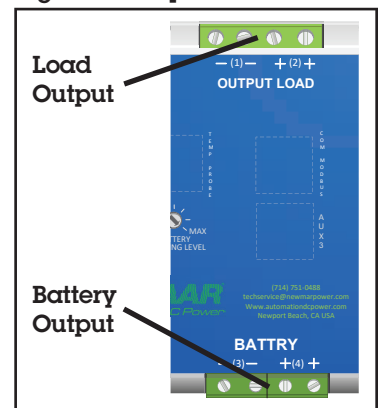
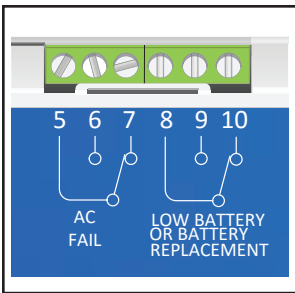

Table 2: Alarm Contacts

Input	Contact				1 AC Fail LED	2 Fault Battery* LED	3 Diagnosis LED
	5-6	5-7	8-9	8-10			
AC only	closed	open	open	closed	off	on	2 Blink-Pause
AC + Batt	closed	open	closed	open	off	off	1 Blink/sec
Batt only	open	closed	closed	open	on	off	off
Low Batt	open	closed	open	closed	on	on	off

* Labeled Low Battery or Battery Replacement on Front Panel

Figure 6: Alarm Contacts Terminals, Form C (Isolated)



Relay Contact Rating:

Max. DC: 30 VDC, 1 amp; AC: 60 VAC, 1 amp; Resistive load (EN 60947-4-1)
Min. 1mA at 5 VDC

D) Optional Battery Temperature Compensation Sensor P/N: 468-4510-0

To install, remove the access tab in the front panel decal labeled "Temp Probe", install the Temp. Sensor into the RJ-45 connector. Attach sensor to side of battery using RTV silicone.

The sensor will vary the battery charging voltage depending on the battery's temperature and charge program setting.

Table 3: Absorption Charge Voltage & Float Charge Voltage Settings

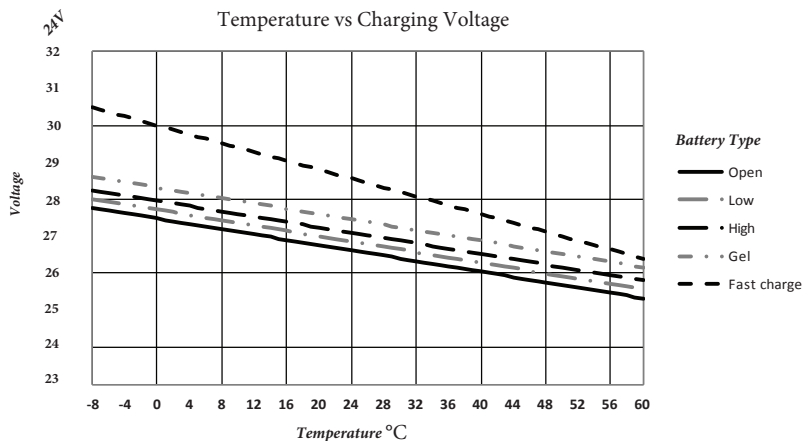

Float Voltage = Voltage @ 20° C - (Sensor Temp ° - 20°) x .003 x number of cells)
Fast Charge = Voltage @ 20° C - (Sensor Temp ° - 20°) x .005 x number of cells)
Eg. Sensor Temp = 60°
Voltage @ 20° = 26.76 (open lead)
Battery Cells = 12
Float: 25.32V = 26.76V - (40 x .003 x 6)

If the battery temperature is less than -20° C or greater than +60° C, an 'outside its range (temp. sensor)' alarm is signalled with code 7 blink.

If the sensor is not connected or if the sensor is defective, the LED Low Batt will illuminate and the LED Diagnosis' LED continues to show the status of the battery, i.e., trickle charge, fast charge or recovery charge.

E. Optional MODBUS: The DIN UPS 24-20 incorporates MODBUS communication protocol over RS-485 serial interface. For details on MODBUS feature and to obtain the MAP file please go to www.poweringthenetwork.com/din-ups/ and download the DIN UPS MODBUS Application Note. To connect to the DIN UPS 24-20 MODBUS serial port remove the access tab in the front panel decal labeled COM MODBUS, see Figure 8.

Figure 7 & 13: Status Indicator LEDs

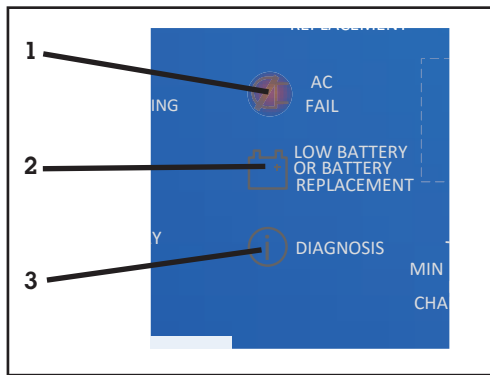
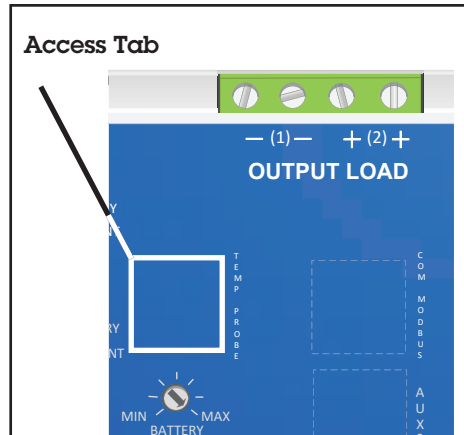

Figure 8: Battery Temperature Sensor Access Tab



4) Settings

A) Battery Type/Charge Curve

Charge curve per battery type: via programming jumpers on top panel of unit left side.

Using programming jumper tabs provided and a small needle nose pliers, insert programming jumpers to select float voltage and enable absorption voltage per per battery type. Caution do not program unit while connected to power.

Figure 9: Battery Type

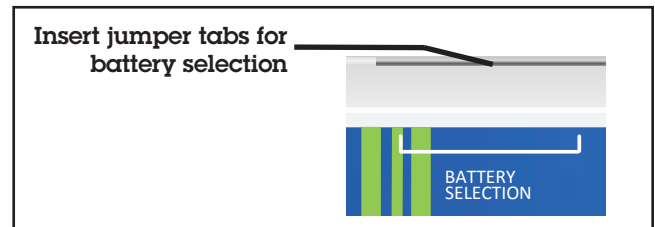

Table 4: Battery Selection/Absorption Charge

Battery Type Selection	Float Charge/ Jumper Insert Position	Absorption Charge Enable/ Jumper Insert Position
Open Lead (Default)	<p>None</p> <p>26.76 VDC</p>	<p>Pos. 6</p> <p>28.8 VDC</p>
Sealed Lead Insert Jumper: Pos. 1	<p>Pos. 1</p> <p>27.0 VDC</p>	<p>Pos. 6</p> <p>28.8 VDC</p>
Gel Battery Insert Jumper: Pos. 2	<p>Pos. 2</p> <p>27.6 VDC</p>	<p>Pos. 6</p> <p>28.8 VDC</p>
Ni-Cad Insert Jumper: Pos. 3	<p>Pos. 3</p> <p>*See note below</p>	<p>Pos. 6</p> <p>31.0 VDC (1.55 VPC x 20 Cells)</p>

Absorption Charge: Unit outputs 29.2 VDC for two minutes, then output is reduced to 28.8 VDC

B) Battery Charge Current Limit/Battery Charge Level

Allows setting maximum current flow to battery during recharge cycle- use when low amp-hour batteries are applied to system to prevent overheating when recovering dead batteries. Adjustment range 20-100% of available charge current. (Available charge current = unit output rating of 20 amps minus load demand. Note: the unit has a load priority circuit, all produced power is made available to the load, remaining power is available for battery charging).

To set, use small slotted screw driver to rotate selector dial. Set dial between 10 to 20% of battery capacity (Amp Hours).

Figure 10: Current Limit/Battery Charge Level - Dial

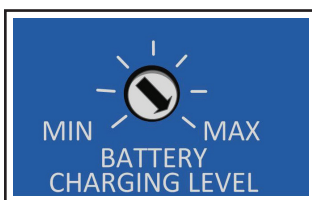

C) Time Buffering/Battery Run Time

This function determines how long the reserve battery will power the system in the event of AC failure. You may choose a specified time or run until the LVD activates.

Settings: dial in time interval of desired run time of battery without disconnect. Using small screw driver to set the dial arrow to the desired setting:

- a. 1 - 60 minutes
- or
- b. Set at zero for battery run until LVD activates @ 18 VDC (1.5 VPC)

Figure 11: Time Buffering/Battery Run Time - Dial

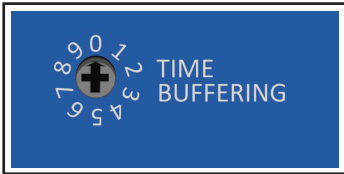

D) System Settings

Via plug-in jumper programming terminals located on top of the unit. Install jumper per illustration below to:

- ii. Enable Battery Test
- iii. Disable/Enable Load Priority

Function Setting		
Battery Test ON Insert Jumper: Pos. 4	Pos. 4	Insert jumper at position 4 to enable Periodic Battery condition test process. (Fault reported by LED diagnosis blink code, see Table 6): <ul style="list-style-type: none"> ▪ Battery wiring connection ▪ Battery efficiency/sulfation (impedance test) ▪ Shorted Cell
Load Priority Disable (Makes full power available for charging) Insert Jumper: Pos. 7	Pos. 7	Jumper inserted into position 7 making all power from the unit available for battery charging by disabling the load priority output function. Under low battery charge condition, output voltage to load will be equal to that of the battery voltage, thus useful voltage to the load will not be available until the battery recovers to proper levels.

5) Operation

A) Battery Start without AC Present Push Button:

If system shuts down due to loss of AC and battery power, pushing button will allow battery to come on line to supply the load. Press and hold for 3 seconds to re-connect battery to output. Note, if LVD has activated and battery voltage has not recovered above disconnect point, the unit will not cycle on.

B) Status Indicator LED's

1. Power source: Mains or back up
 - i. AC OK (AC Fail LED Off)
 - or
 - ii. Operating on battery backup power (AC Fail LED On) red
2. Low battery, or battery replacement

LED illuminates when:

- Low Battery (capacity less than 30%)
- Bad connection to battery
- Battery requires replacement

3 diagnosis LED.

Charger output status system diagnosis and Fault mode diagnosis: by blink code (Table 6 on next page).

Figure 12: Battery Start LED

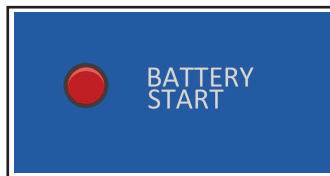

Figure 13: Status Indicator LEDs

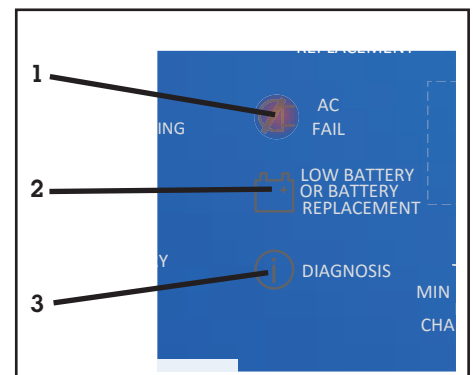













Table 6: Status Indicator LEDs

Monitoring Control	State	LED Diagnosis (No.3)	LED Battery Fault (No.2)
Charging Type	Float	1 Blink/sec	OFF
	Absorption	2 Blink/sec	OFF
	Bulk	5 Blink/sec	OFF
System Auto Diagnosis	Reverse polarity or high battery Voltage	1 Blink/pause* 	ON
	Battery Not connected, no output power	2 Blink/pause 	ON
	Battery shorted cell	3 Blink/pause 	ON
	Over Load or short circuit on the load	4 Blink/pause 	ON
	Bad battery; Internal impedance Bad or Bad battery wire connection	5 Blink/pause 	ON
	Battery Life test not possible	6 Blink/pause 	ON
	Temp. Sensor outside its range	7 Blink/pause 	ON
	Boost condition; battery discharge after 4 min. of overload.	8 Blink/pause 	ON
	Internal fault	9 Blink/pause 	ON
	Low battery detected when system activated by battery start button with no ac input	10 Blink/pause 	ON
Life test not possible; Parallel mode on Slave Device	12 Blink/pause 		
Bad battery wire connection; Parallel mode on Slave Device	13 Blink/pause 		

* Pause: 1 Second

C) LVD)

The unit contains a low voltage load disconnect that activates at 18 volts (1.5 vpc) which is factory set and cannot be user modified. (See also Section 4-C regarding operation with battery time out circuit)

6) Protection

On the AC Input: the device is equipped with an internal fuse. If the internal fuse is blown, it is most probable that there is a fault in the unit. If this occurs, the unit must be returned to the factory.

On the DC Output Battery and Load: The device is electrically protected.

Reverse polarity: the module is automatically protected against reverse of battery polarity and connection of reverse polarity.

Over current and output short circuit: the unit limits the output current. Low voltage disconnect protects battery from deep discharge.



Thermal protection

Operating temperature range -12 to 70° C. Unit will produce full rated power on continuous basis to 50° C, however; system load must be reduced by 2.5% per 1° for continuous operation above 50° C. If the temperature reaches 70° C, the unit will reduce its maximum output to approximately 50% of its rating. If the temperature exceeds 70° C, the unit will shut off and restart once temperature drops.

7) Specifications

Input:

Voltage: 90-135/ 180-305 47-63 hz

Amperage: 8 @ 120 VAC / 4.2 @ 230 VAC

Output: 24 volts, 20 amps total available to power loads and charge battery, with load priority distribution.

Peak: 40 amps 4 seconds (with battery power boost)

Output ground isolated from case.

Front Panel LED Indicators:

- Power Source: operating on back up – red AC Fail LED
- Battery and System Diagnostics (via blink code)

Settings/Selectors:

- Battery Type: AGM (Sealed Lead), Open Lead Acid (Flooded), Gel-Cell and Ni-Cad (20 Cell)

Battery Charge Current Limit: 20 - 100% of charge
amperage rating

Back-Up Run Time on Batteries:

- Programmed time limit: 1 - 60 min.
Or
- Until LVD disconnect @ 18V

Power Restore Button: connects battery without AC present

Alarm Contacts (form C): Active:

- AC Fail (on battery back-up)
- Battery abnormal condition (summary contact): Discharged, damaged, disconnected, sulfated/short circuit, reverse polarity, bad thermal sensor

Operating Temperature: -12 to 70° C. Continuous to 50°, de-rate 2.5% per° C >50° C

Cooling: Free air convection

Efficiency: 91%

Humidity: 95% to 25° C (non-condensing)

Protection:

- Low Voltage disconnect at 1.5 volts per cell (18 VDC)
- Internal fuse
- Current limiting
- Short circuit
- Reverse polarity
- Thermal overload shut down and recovery
- IP 20
- Designed to UL 1950

Terminal Blocks: Screw type

Mounting: DIN Rail Bracket 35 mm

8) Troubleshooting

Symptom	Possible Cause	Corrective Action	Section
A. Battery requires excessive re-charge time	<ol style="list-style-type: none"> 1. Load at or near max. recommended load providing minimal current available for charging 2. Charging level current set to low 	<ol style="list-style-type: none"> 1. Reduce load or split load between two separate DIN UPS units 2. Adjust "Battery Charging Level" control knob to higher level 	
B. Load turns off after a couple of seconds when running on battery	<ol style="list-style-type: none"> 1. Time buffer set to incorrect position 2. Batteries not charged, due to high load demand 	<ol style="list-style-type: none"> 1. Verify correct setting with manual 2. Reduce load or split load between two separate DIN UPS units 	
C. No absorption voltage	<ol style="list-style-type: none"> 1. Absorption jumper not installed 	<ol style="list-style-type: none"> 1. Install provided jumper in position 6 	
D. Unit does not turn on	<ol style="list-style-type: none"> 1. AC input is 115 VAC, no jumper wire installed 	<ol style="list-style-type: none"> 1. Install 115V jumper wire across j1 and j2 	
E. Trips AC input breaker	<ol style="list-style-type: none"> 1. AC shorted to case 2. Defective unit 	<ol style="list-style-type: none"> 1. Verify correct AC input wiring 2. Contact technical service 	
F. No output	<ol style="list-style-type: none"> 1. DC output wired backwards or shorted 2. No AC input 3. Excessive temperature or blocked ventilation 4. Defective unit 	<ol style="list-style-type: none"> 1. Remove AC input and check DC wiring 2. Verify correct AC input and jumper wire installed if powering from 115 VAC 3. Improve ventilation, unblock vent holes 4. Contact technical service 	
G. No voltage on battery output terminals	<ol style="list-style-type: none"> 1. No battery installed (voltage required for battery output to turn on) 2. Missing or blown battery wiring fuse 	<ol style="list-style-type: none"> 1. Install batteries 2. Replace missing or blown battery wiring fuse 	
H. Diagnosis LEDs always blinking	<ol style="list-style-type: none"> 1. Normal operation 	<ol style="list-style-type: none"> 1. Refer to Chart 2: Diagnosis Table 	

9) Warranty

Newmar warrants that the DIN-UPS 24-20 DIN Rail UPS to be free from defects in material and workmanship for two years from date of purchase. If a problem with your DIN-UPS 24-20, or if you have any questions about the installation and proper operation of the unit, please contact NEWMAR's Technical Services Department:

Phone: 714-751-0488 - From the hours of 7:30 a.m. to 5:00 p.m. weekdays, P.S.T.;

Fax: 714-957-1621

E-mail: techservice@newmarpower.com